

TSURUMI AVANT

MY SERIES

MYB (Open Channel)

MYU (Vortex)

MYG (Grinder)

MYS (High Head)

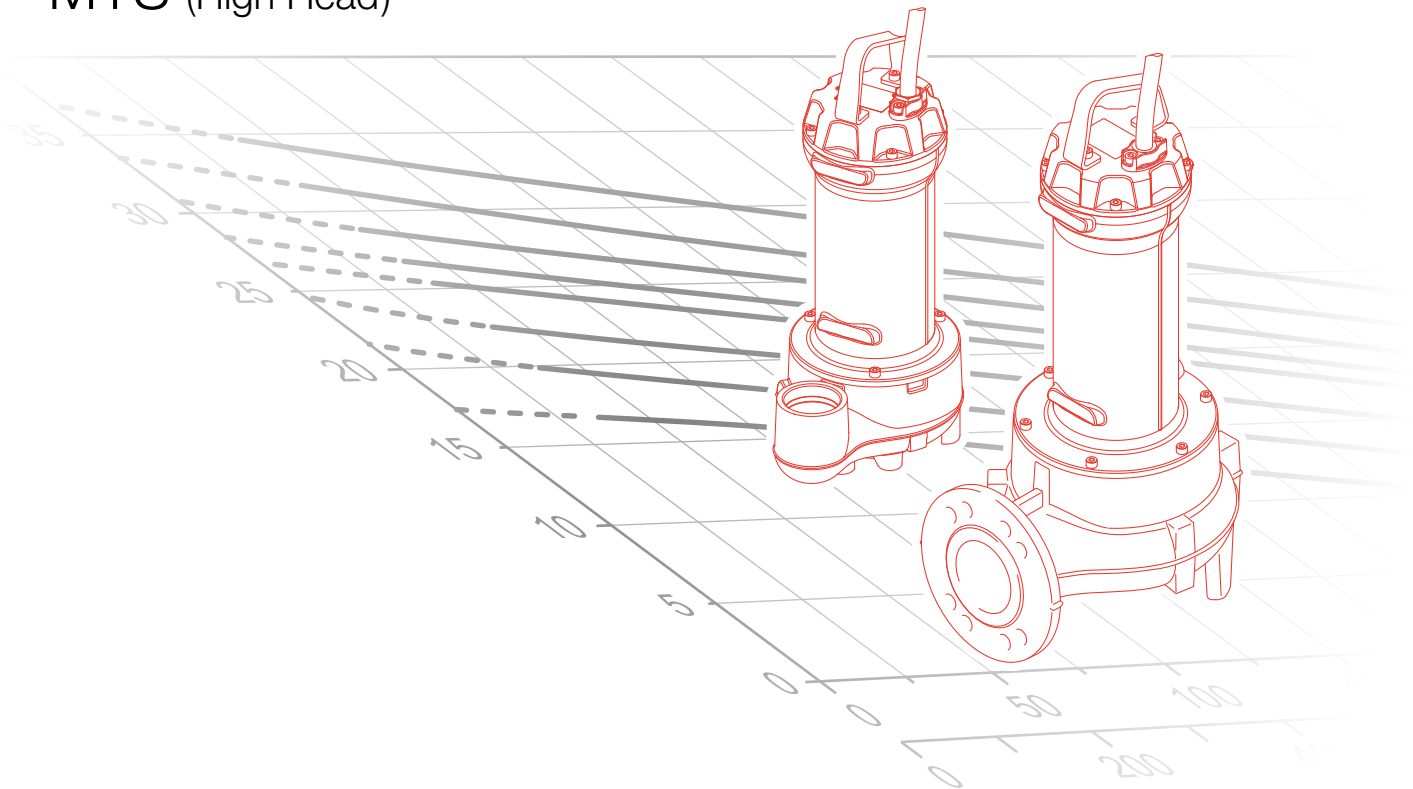



TSURUMI AVANT

MY SERIES

MYB

MYU

MYG

MYS



D A T A B O O K L E T

MY Series

General characteristics

Motor

- Electrical submersible pumps in GJL-250 cast iron
- Two silicon carbide (2SiC) mechanical seals in oil sump
- Ecological dry motor with thermal protection
- Sensor for detecting water in the mechanical seal oil sump
- Self lubricated ball bearings



Hydraulic families

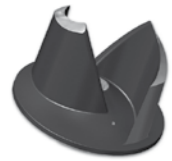

MYB (Open Channel)

- Multi-channel open impeller
- Designed for mainly professional and industrial use such as wastewater treatment plants, sewage systems and livestock farms, it is particularly suitable for the treatment of liquids containing suspended solids or filaments, and low or medium density activated sludges.

page 7

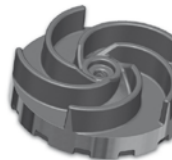

MYU (Vortex)

- Set-back vortex impeller
- Used with unstrained soiled biological wastewaters and sewage and for civil lifting applications. It is thus ideal for wastewater treatment plants, sewer systems, livestock farms, industry and agriculture.

page 33

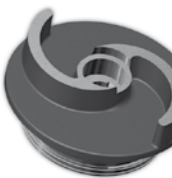

MYG (Grinder)

- Impeller with grinder system
- Designed for professional and industrial use, it is suitable for the treatment of liquids containing suspended solids or fibres, and low or medium density activated sludges.

page 45



MYS (High Head)

- High head impeller
- Suitable for clear wastewater, rainwater and seepage. The considerable manometric head guarantees excellent results for the creation of water features and decorative fountains; suitable for use in agriculture, irrigation and the fish processing sector.

page 49

Operating ranges

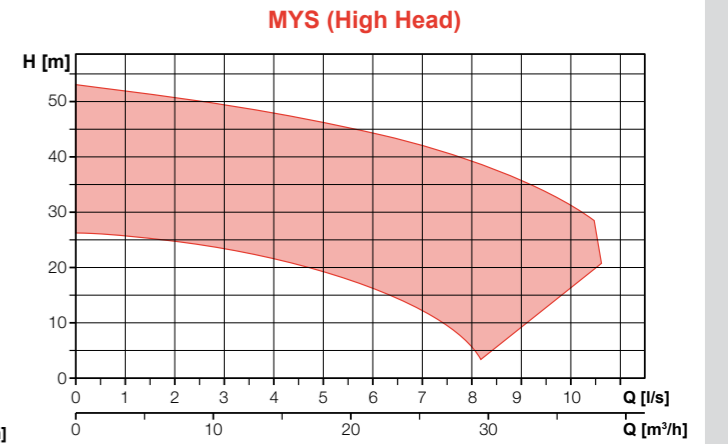
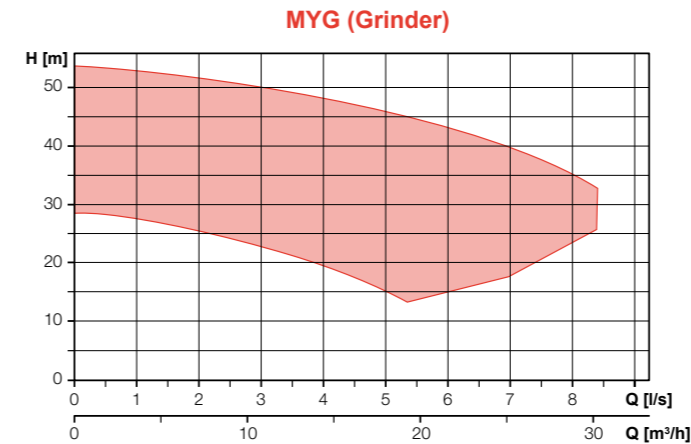
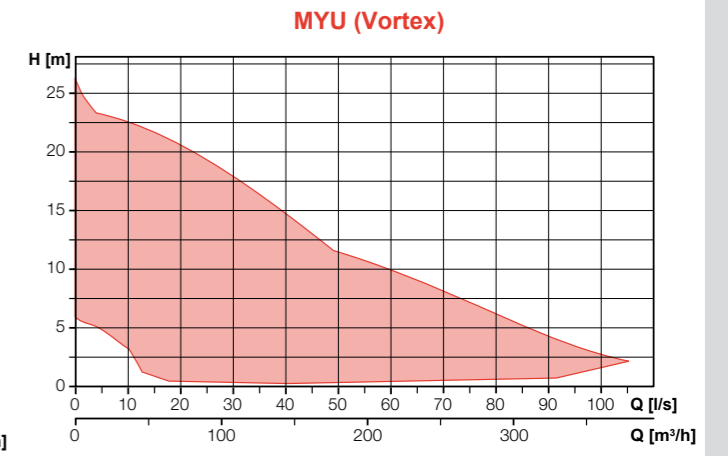
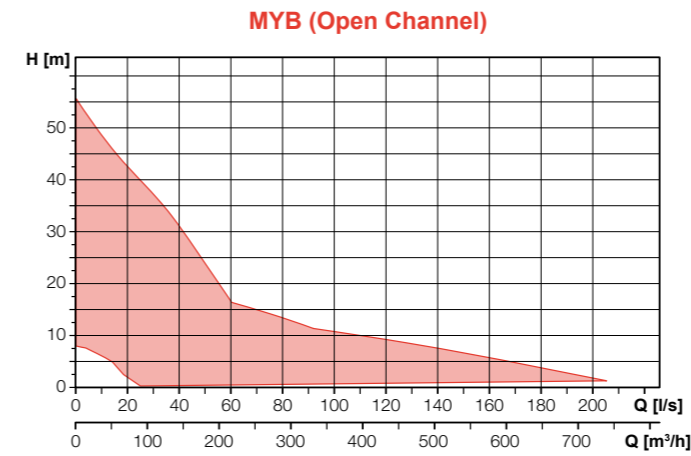

Versions available

• Electrical variants

- NAE** No electric accessories
- TS** Thermal protection, sensor for detecting water in the mechanical seal oil sump

• Cooling system

- N** No cooling and/or seal flushing system

• Set of mechanical seals

- 2SiC** 2 mechanical seals in silicon carbide

Key to product code

MYU 300/2/G65V C0ET5

① ② (A) (B) (C) ③ ④ ⑤ ⑥ ⑦ ⑧

- ① Series
- ② Power (HPx100) / motor poles
- ③ Delivery rate
 - (A) TYPE (GAS thread/Flanged)
 - (B) DIAMETER (mm)
 - (C) POSITION
 - V = vertical
 - H = horizontal
- ④ Hydraulic model
- ⑤ Version number
- ⑥ Motor size
- ⑦ Motor phases
 - M = Single-phase
 - T = Three-phase
- ⑧ Power supply voltage frequency
 - 5 = 50Hz
 - 6 = 60Hz

Installations

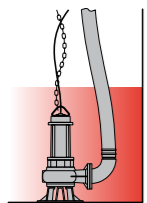

Free installation

The electric pump, standing on its feet or base, is connected to the delivery flexible pipe using a joint fixed to the discharge. This installation allows to move easily the electrical pump.

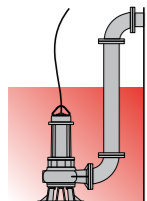

Fixed installation

The electric pump, standing on its feet or base, is connected to the delivery pipe, which is screwed to the discharge if threaded, or fixed to a bend if the port is flanged. The pump-hose connection may be threaded or flanged, depending on the pump fitting.

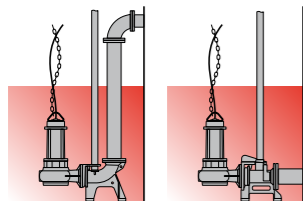

Installation with base coupling foot

Available for electric pumps with threaded discharge. The pump unit is supported by a special device fitted to the delivery pipe. This device can be installed at any time without having to empty the tank. It simplifies any maintenance work on the pump, which can be lifted out and resubmerged with great ease. It is recommended in particular for installations of small size, and does not require the pump to be resting on the bottom of the tank.

Open channel impeller

Operating ranges

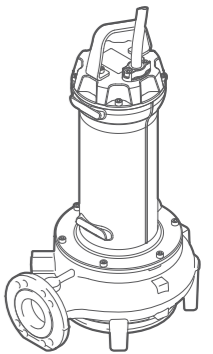
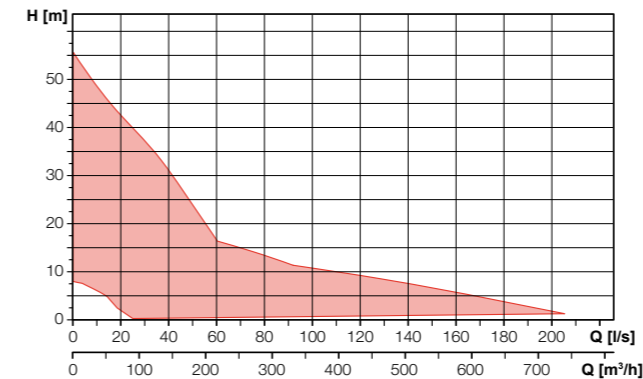

Range characteristics

Motor power	1.8 - 18.5 kW
Poles	2 / 4 / 6
Insulation class	H
Degree of protection	IP68
Discharge	GAS 2½" vertical DN65 - DN250 horizontal max 100 x 70 mm
Free passage	max 100 x 70 mm
Max flow rate	205 l/s
Max head	48.3 m

Motor

Ecological dry motor with thermal protections

Cable

S1RN8-F electric cable. Standard version 10 m cable length

Mechanical seals

Two silicon carbide (SiC) mechanical seals in oil sump

Applications

It is particularly suitable for the treatment of liquids containing suspended solids or filaments, and low or medium density activated sludges.

Versions

Electrical variants	NAE, TS
Cooling system	N
Mechanical seals	2SiC

Operating specifications

Max operating temperature	40 °C
PH of treated fluid	6 - 14
Viscosity of treated fluid	1 mm²/s
Maximum immersion depth	20 m
Density of treated fluid	1 Kg/dm³
Acoustic pressure max	<70dB
Max starts per hour	30

Construction materials

Case	Cast iron EN-GJL 250
Hydraulic parts	Cast iron EN-GJL 250
Impeller	Cast iron EN-GJL 250
Nuts and bolts	Stainless steel - Class A2-70
Standard gasket	Rubber - NBR
Shaft	Stainless steel - AISI 431
Paint type	Ecological bicomponent epoxy (~ 200 µm)

Installations

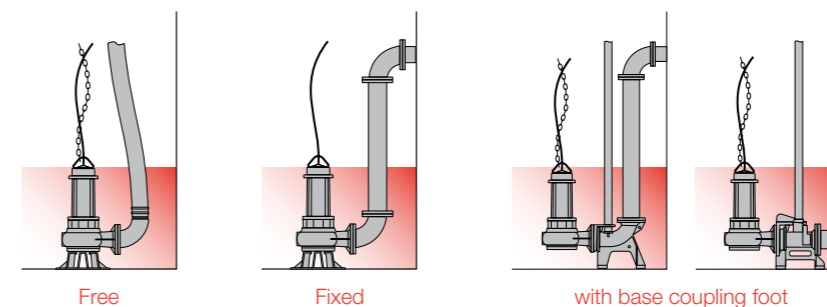

MYB 250-300-400/2/G65V

MYB 150 - 550/2/65

Performances

l/s	0	4	8	12	16	20	24
l/min	0	240	480	720	960	1200	1440
m³/h	0	14.4	28.8	43.2	57.6	72	86.4

1 MYB 250/2/G65V B0AT5	17.6	13.9	11.3	8.9	6.1	3.6
2 MYB 300/2/G65V A0ET5	20.0	16.3	13.8	10.9	8.1	5.7
3 MYB 400/2/G65V A0ET5	24.6	20.7	17.8	15.0	11.9	9.1

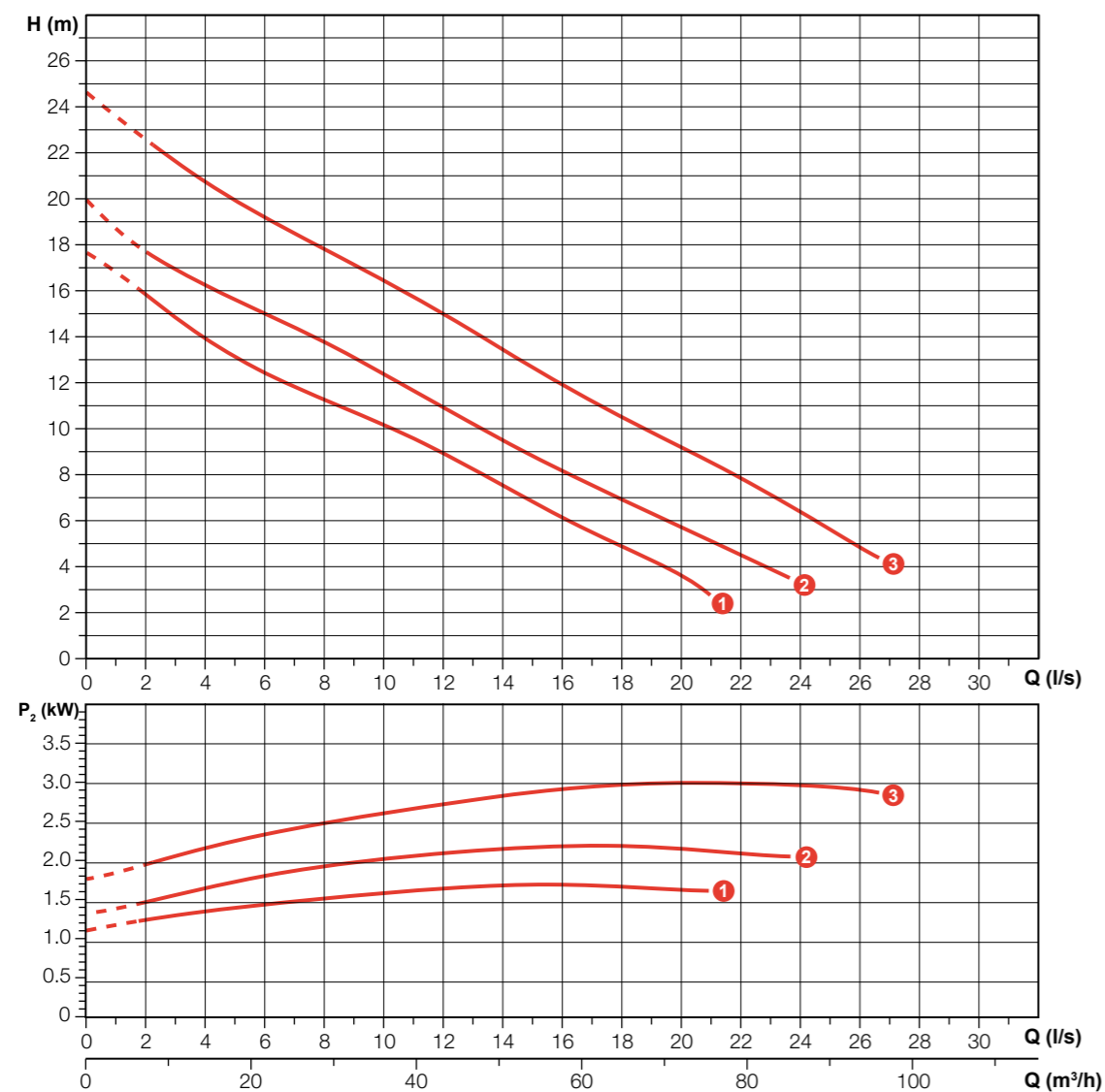

Characteristic curves according to UNI EN ISO 9906

Technical data

	V	Phases	P1 (kW)	P2 (kW)	A	Rpm	Start	Cable	Ø	Free passage
1 MYB 250/2/G65V B0AT5	400	3	2.19	1.8	3.7	2900	Dir	4G1	G 2½"	35x30 mm
2 MYB 300/2/G65V A0ET5	400	3	2.76	2.2	4.62	2900	Dir	4G1.5+3x1	G 2½"	40x35 mm
3 MYB 400/2/G65V A0ET5	400	3	3.68	3.0	6.36	2900	Dir	4G1.5+3x1	G 2½"	40x35 mm

80 mm discharge bore available

Performances

l/s	0	4	8	12	16	20	24	28
l/min	0	240	480	720	960	1200	1440	1680
m³/h	0	14.4	28.8	43.2	57.6	72.0	86.4	100.8

1 MYB 150/2/65 B0AT5	119	9.7	8.0	6.1	3.9			
2 MYB 200/2/65 B0AT5	15.6	12.6	10.5	8.5	5.8	3.5		
3 MYB 250/2/65 B0AT5	16.7	13.5	11.4	9.5	6.9	4.3		
4 MYB 300/2/65 A0ET5	17.9	15.8	13.6	11.2	8.7	6.1	3.3	
5 MYB 400/2/65 A0ET5	22.8	19.9	17.5	15.0	12.5	9.6	6.5	
6 MYB 550/2/65 C0FT5	26.4	23.3	20.9	18.8	16.5	13.9	11.1	8.1

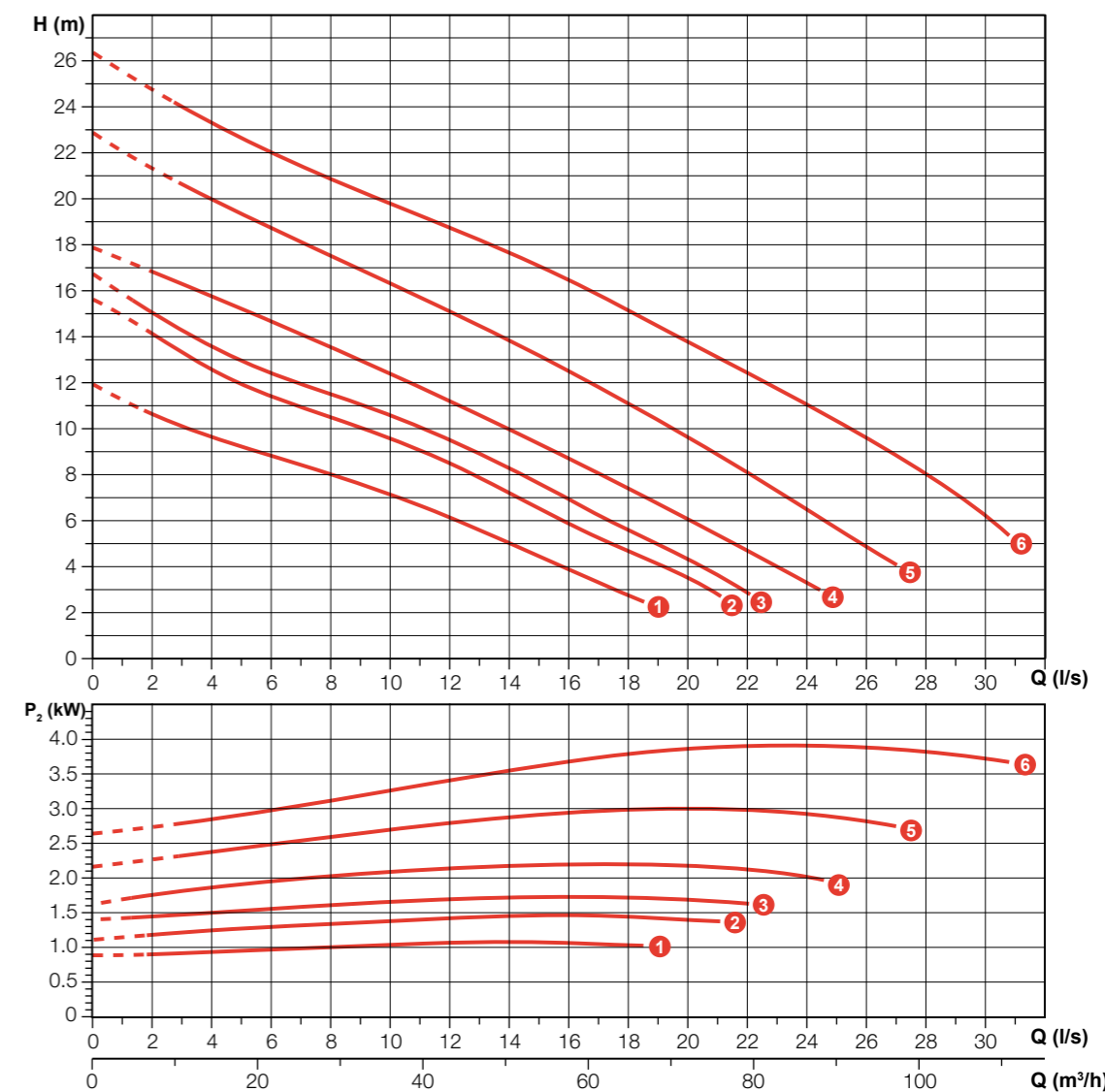

Characteristic curves according to UNI EN ISO 9906

Technical data

	V	Phases	P1 (kW)	P2 (kW)	A	Rpm	Start	Cable	Ø	Free passage
1 MYB 150/2/65 B0AT5	400	3	1.33	1.1	2.43	2900	Dir	4G1.5+3x1	DN65	35x30 mm
2 MYB 200/2/65 B0AT5	400	3	1.82	1.5	3.25	2900	Dir	4G1.5+3x1	DN65	35x30 mm
3 MYB 250/2/65 B0AT5	400	3	2.19	1.8	3.7	2900	Dir	4G1	DN65	35x30 mm
4 MYB 300/2/65 A0ET5	400	3	2.76	2.2	4.62	2900	Dir	4G1.5+3x1	DN65	40x35 mm
5 MYB 400/2/65 A0ET5	400	3	3.68	3.0	6.36	2900	Dir	4G1.5+3x1	DN65	40x35 mm
6 MYB 550/2/65 C0FT5	400	3	4.66	4.0	7.73	2900	Dir	4G1.5+3x1	DN65	40x35 mm

80 mm discharge bore available

MYB 250-300-400-550/2/80

Performances

l/s	0	4	8	12	16	20	24	28
l/min	0	240	480	720	960	1200	1440	1680
m³/h	0	14.4	28.8	43.2	57.6	72	86.4	100.8

1 MYB 250/2/80 LOAT5	17.0	13.4	11.3	9.2	6.6	4.0	1.3
2 MYB 300/2/80 E0ET5	18.4	15.9	13.6	11.4	9.1	6.9	4.7
3 MYB 400/2/80 E0ET5	23.5	20.3	17.7	15.1	12.4	9.6	6.6
4 MYB 550/2/80 P0FT5	26.2	23.3	20.8	18.5	16.1	13.3	10.3

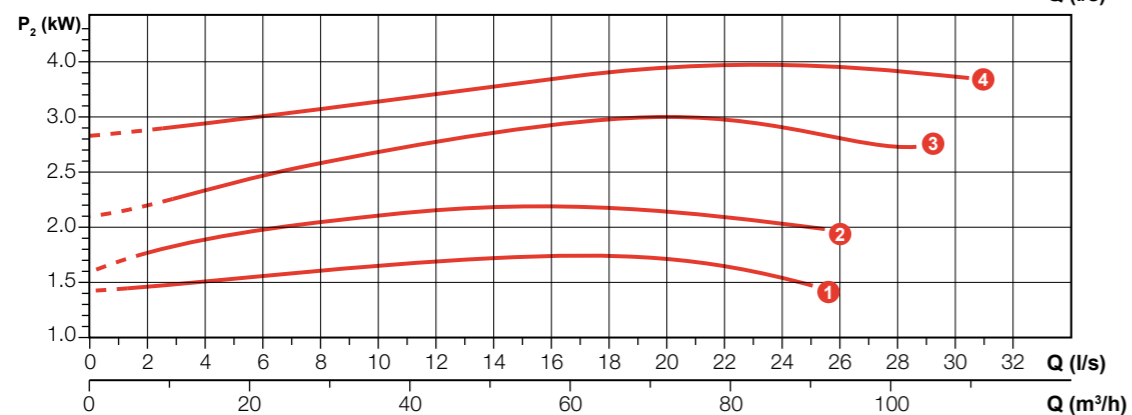
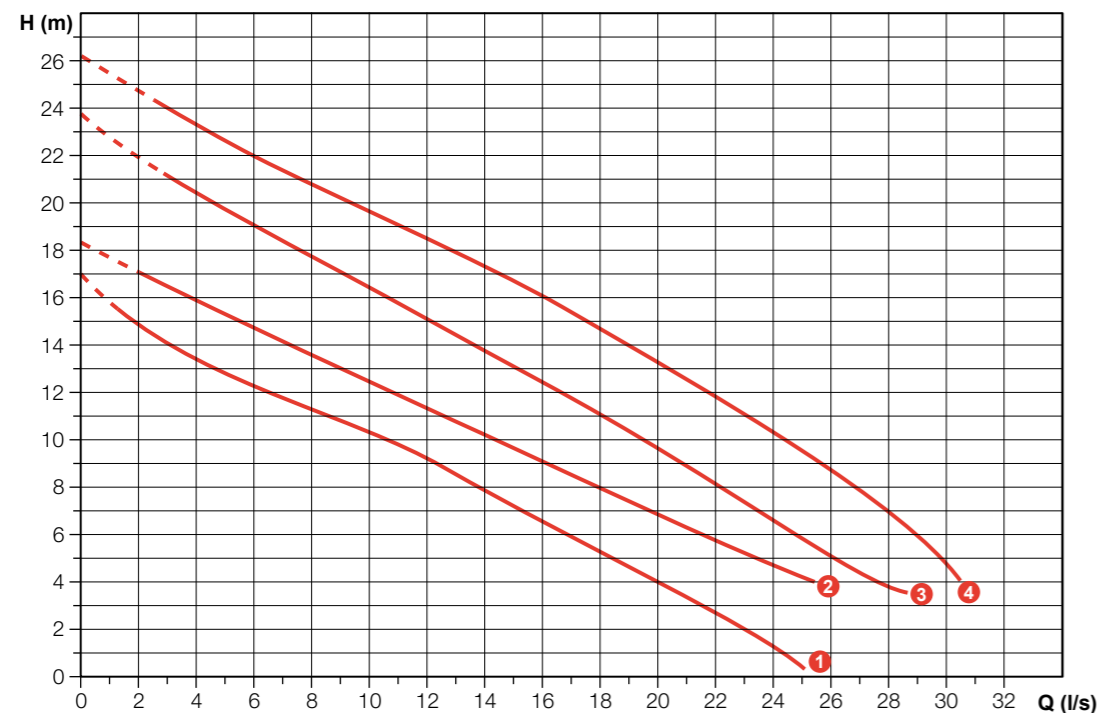

Characteristic curves according to UNI EN ISO 9906

MYB 750-1000-1200-1500/2/80 A

Performances

l/s	0	4	8	12	16	20	24	28	32	36	40	44
l/min	0	240	480	720	960	1200	1440	1680	1920	2160	2400	2640
m³/h	0	14.4	28.8	43.2	57.6	72	86.4	100.8	115.2	129.6	144	158.4

1 MYB 750/2/80 A0FT5	27.0	24.7	22.0	19.3	16.9	14.7	12.8	10.8	8.6	6.0	2.6
2 MYB 1000/2/80 A0FT5	38.6	34.2	30.6	27.6	24.7	21.8	19.0	16.3	13.7	11.1	8.3
3 MYB 1200/2/80 A0GT5	42.8	38.6	35.1	32.1	29.3	26.4	23.2	19.9	16.6	13.4	10.5
4 MYB 1500/2/80 A0GT5	46.5	41.5	38.5	35.7	32.8	29.6	24.5	23.4	20.2	16.7	13.0

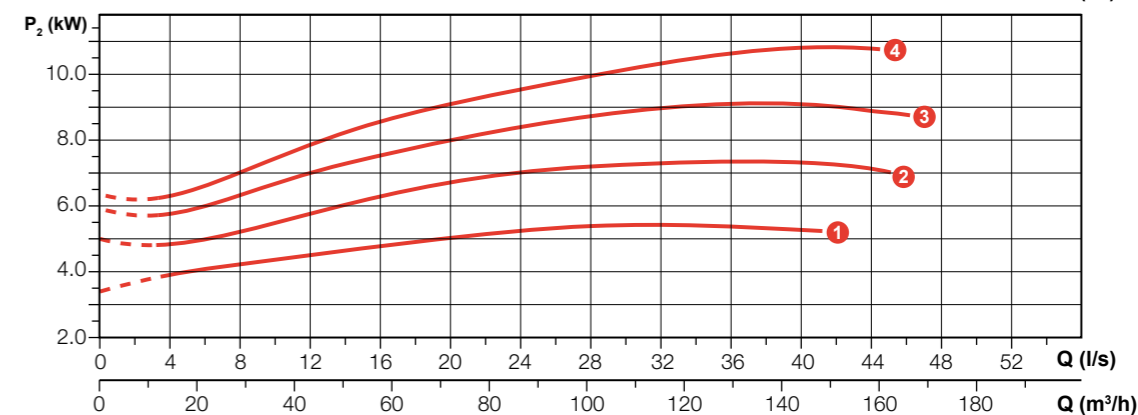
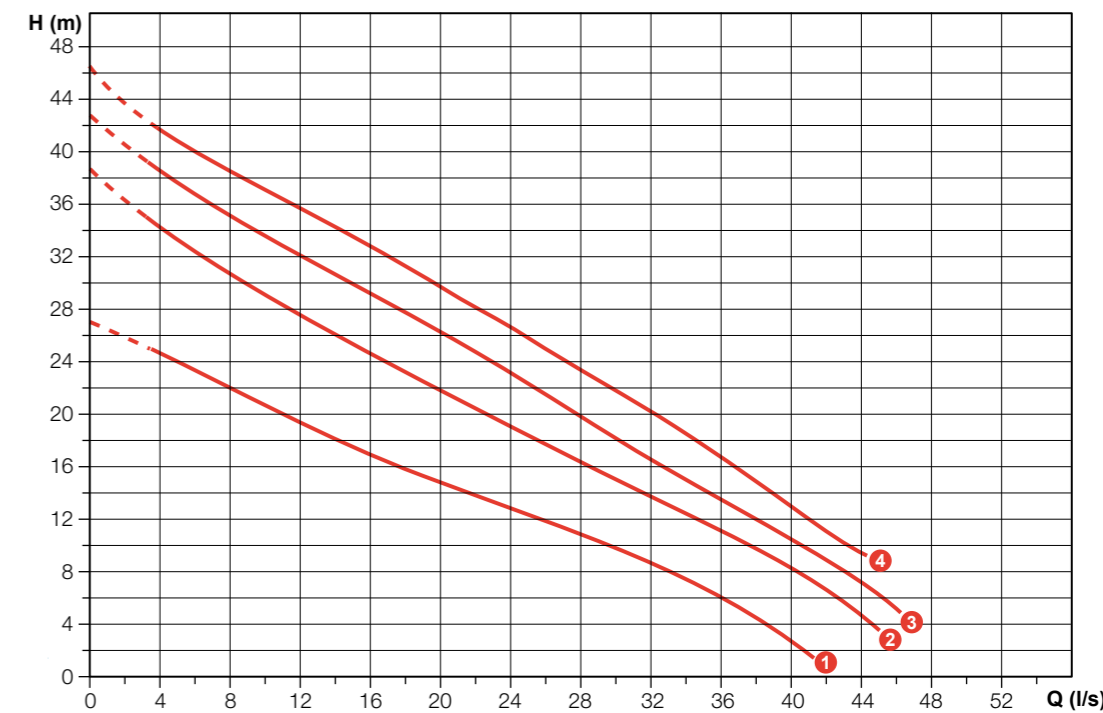

Characteristic curves according to UNI EN ISO 9906

Technical data

	V	Phases	P1 (kW)	P2 (kW)	A	Rpm	Start	Cable	Ø	Free passage
1 MYB 250/2/80 LOAT5	400	3	2.19	1.8	3.7	2900	Dir	4G1	DN80	35x30 mm
2 MYB 300/2/80 E0ET5	400	3	2.76	2.2	4.62	2900	Dir	4G1.5+3x1	DN80	40x35 mm
3 MYB 400/2/80 E0ET5	400	3	3.68	3.0	6.36	2900	Dir	4G1.5+3x1	DN80	40x35 mm
4 MYB 550/2/80 P0FT5	400	3	4.66	4.0	7.73	2900	Dir	4G1.5+3x1	DN80	40x35 mm

Technical data

	V	Phases	P1 (kW)	P2 (kW)	A	Rpm	Start	Cable	Ø	Free passage
1 MYB 750/2/80 A0FT5	400	3	6.32	5.5	10.8	2900	Dir	4G1.5+3x1	DN80	40 mm
2 MYB 1000/2/80 A0FT5	400	3	8.51	7.5	13.7	2900	Dir	4G1.5+3x1	DN80	40 mm
3 MYB 1200/2/80 A0GT5	400	3	10.4	9.0	16.1	2900	YΔ	7G1.5+3x1	DN80	40 mm
4 MYB 1500/2/80 A0GT5	400	3	12.6	11.0	19.5	2900	YΔ	7G1.5+3x1	DN80	40 mm

MYB 550-750-1000-1200-1500/2/80 B

MYB 2000-2500/2/80 G

Performances

	l/s	0	4	8	12	16	20	24	28	32	36	40	44	48
	l/min	0	240	480	720	960	1200	1440	1680	1920	2160	2400	2640	2880
	m ³ /h	0	14.4	28.8	43.2	57.6	72	86.4	100.8	115.2	129.6	144	158.4	172.8
1	MYB 550/2/80 B0FT5	18.6	16.3	14.4	12.5	10.7	9.1	7.9	6.9	5.9	4.2			
2	MYB 750/2/80 B0FT5	23.4	21.3	19.1	17.0	14.9	13.0	11.1	9.4	7.8	6.1	4.3		
3	MYB 1000/2/80 B0FT5	30.9	28.5	26.0	23.6	21.2	19.0	16.8	14.6	12.4	10.2	7.8	5.6	3.6
4	MYB 1200/2/80 B0GT5	35.0	31.7	28.9	26.5	24.3	22.1	19.8	17.4	14.8	12.4	10.2	8.1	5.9
5	MYB 1500/2/80 B0GT5	41.7	36.1	32.8	30.4	28.2	25.9	23.5	21.1	18.8	16.5	14.2	11.9	

Performances

	l/s	0	4	8	12	16	20	24	28	32	36	40	44	48
	l/min	0	240	480	720	960	1200	1440	1680	1920	2160	2400	2640	2880
	m ³ /h	0	14.4	28.8	43.2	57.6	72	86.4	100.8	115.2	129.6	144	158.4	172.8
1	MYB 2000/2/80 G0HT5	45.0	41.6	38.1	35.0	32.3	29.9	27.6	25.2	22.6	20.0	17.5	14.9	
2	MYB 2500/2/80 G0HT5	48.3	46.0	42.7	39.5	36.8	34.3	32.0	29.5	27.0	24.3	21.7	19.0	15.6

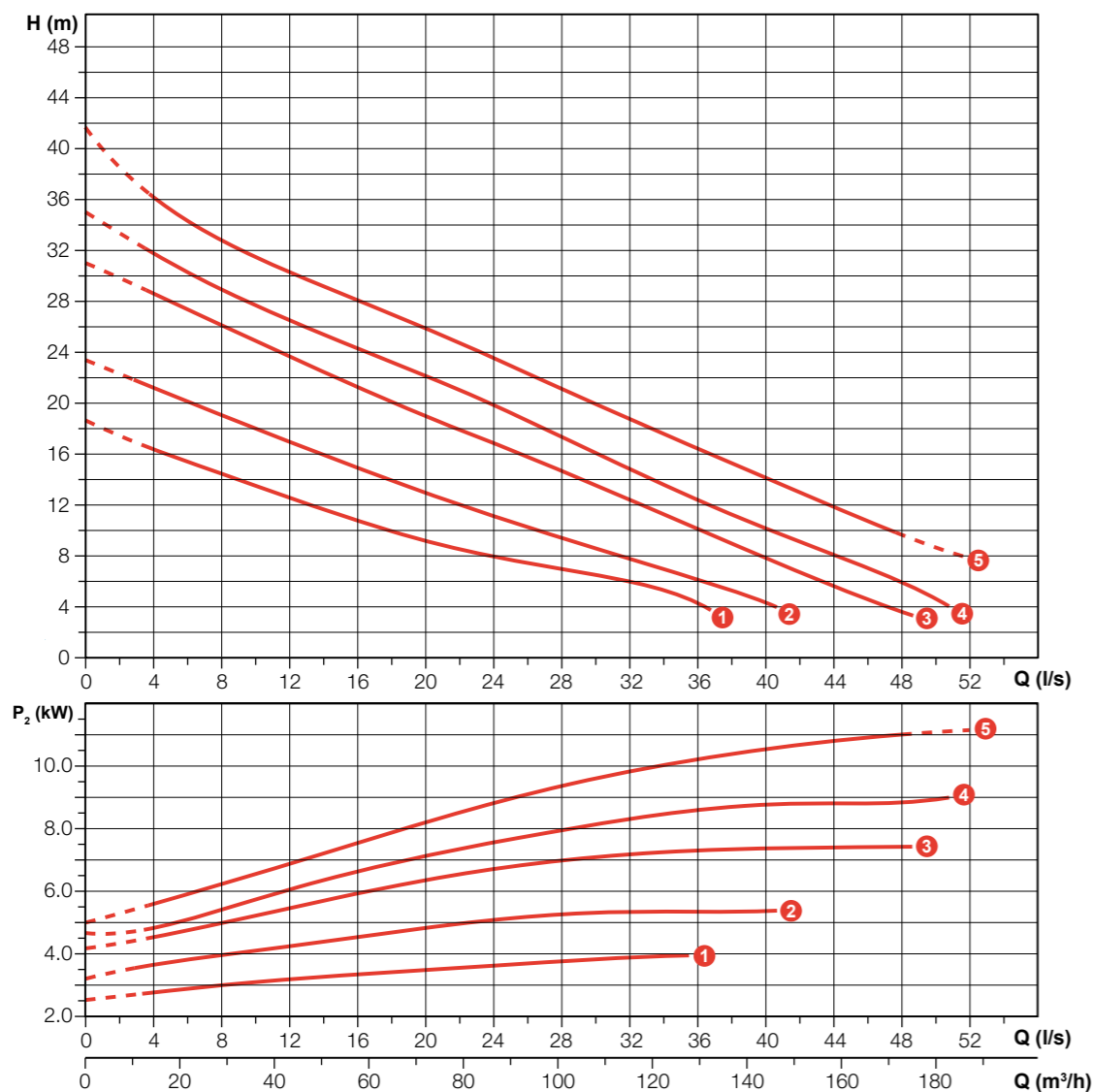

Characteristic curves according to UNI EN ISO 9906

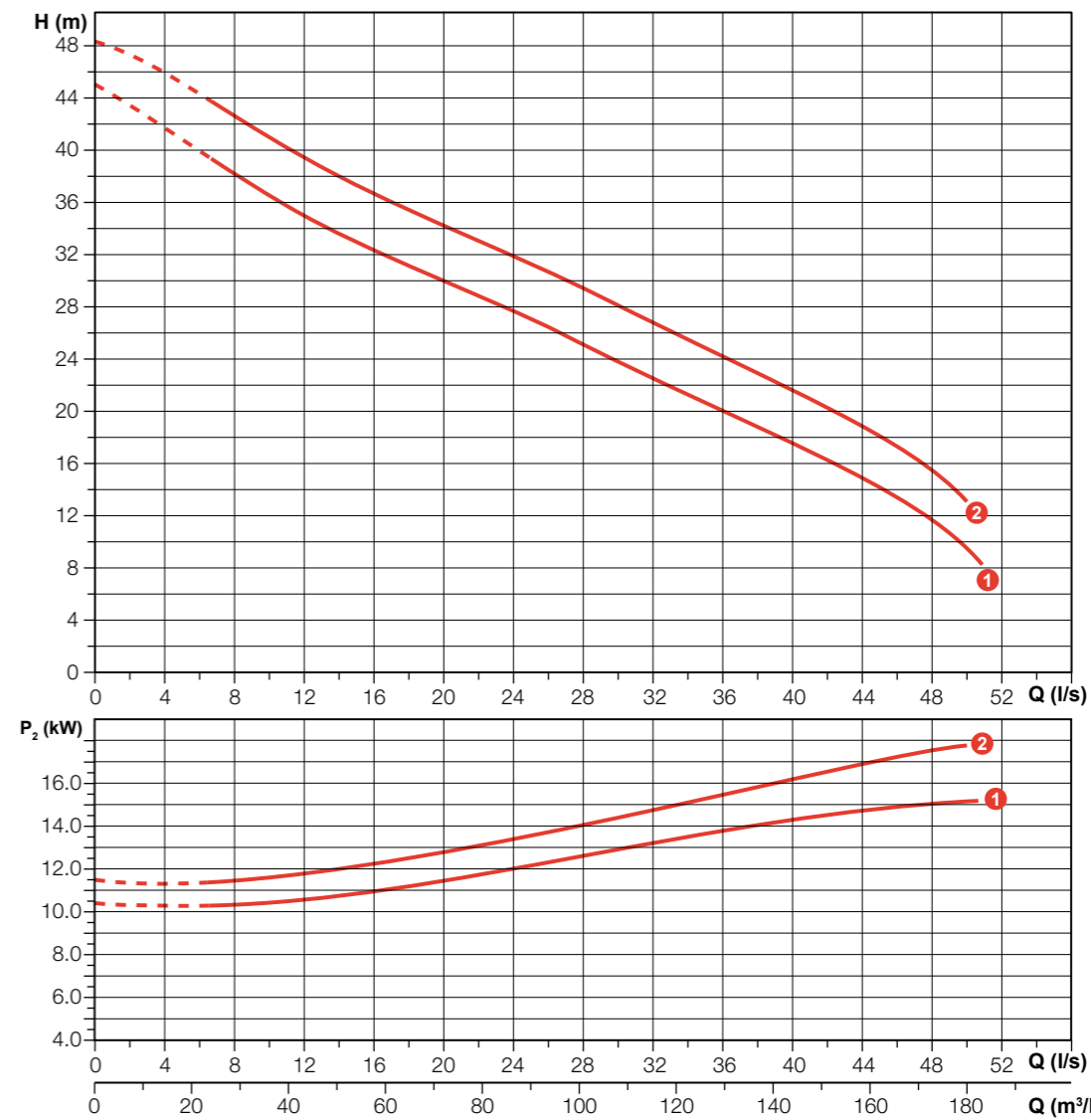

Characteristic curves according to UNI EN ISO 9906

Technical data

	V	Phases	P1 (kW)	P2 (kW)	A	Rpm	Start	Cable	Ø	Free passage
1	400	3	4.66	4.0	7.73	2900	Dir	4G1.5+3x1	DN80	55x50 mm
2	400	3	6.32	5.5	10.8	2900	Dir	4G1.5+3x1	DN80	50x55 mm
3	400	3	8.51	7.5	13.7	2900	Dir	4G1.5+3x1	DN80	50x55 mm
4	400	3	10.4	9.0	16.1	2900	Y Δ	7G1.5+3x1	DN80	40 mm
5	400	3	12.6	11.0	19.5	2900	Y Δ	7G1.5+3x1	DN80	40 mm

Technical data

	V	Phases	P1 (kW)	P2 (kW)	A	Rpm	Start	Cable	Ø	Free passage
1	400	3	16.9	15.0	26.2	2900	Y Δ	7G1.5+3x1	DN80	75 mm
2	400	3	20.7	18.5	32.9	2900	Y Δ	7G2.5+3x1	DN80	75 mm

MYB 2000-2500/2/80 W

MYB 1200-1500/2/100

Performances

	l/s	0	8	16	24	32	40	48	56	64
	l/min	0	480	960	1440	1920	2400	2880	3360	3840
	m ³ /h	0	28.8	57.6	86.4	115.2	144	172.8	201.6	230.4
①	MYB 2000/2/80 W0HT5	46.7	39.4	35.7	32.1	28.0	23.4	18.5	12.9	6.9
②	MYB 2500/2/80 W0HT5	55.5	49.9	44.7	40.4	36.1	31.1	25.5	19.7	13.7

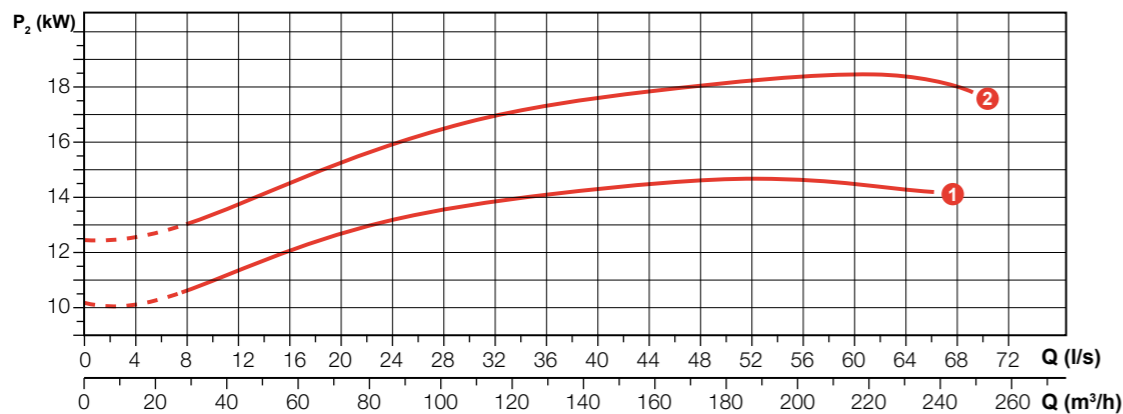
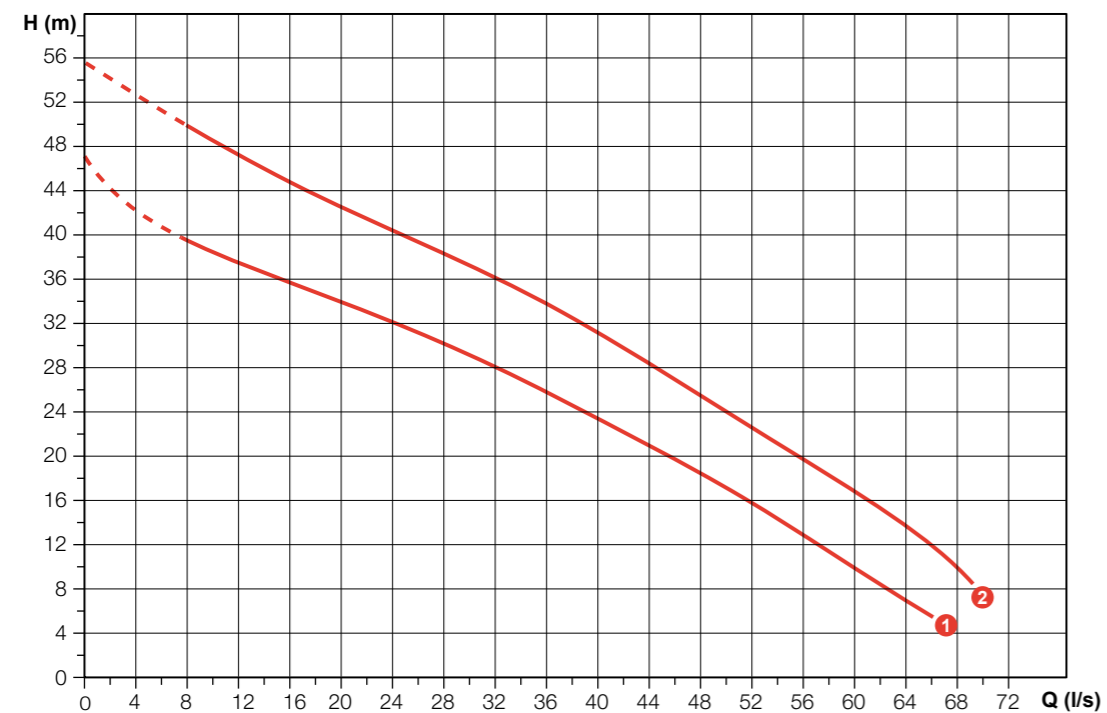

Characteristic curves according to UNI EN ISO 9906

Performances

	l/s	0	8	16	24	32	40	48	56	64
	l/min	0	480	960	1440	1920	2400	2880	3360	3840
	m ³ /h	0	28.8	57.6	86.4	115.2	144	172.8	201.6	230.4
①	MYB 1200/2/100 K0GT5	35.8	31.0	26.2	22.6	19.1	14.8	10.3	6.3	
②	MYB 1500/2/100 K0GT5	38.8	34.2	29.3	25.8	22.2	17.6	12.9	9.1	4.4

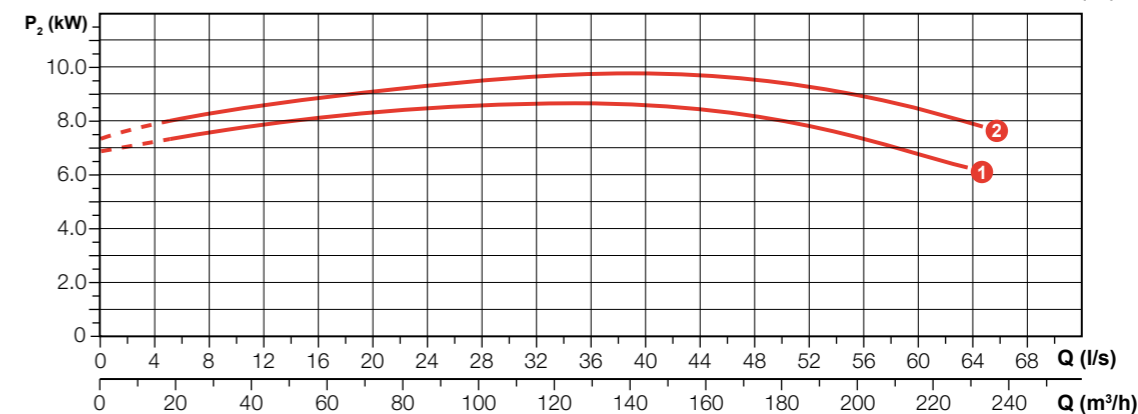
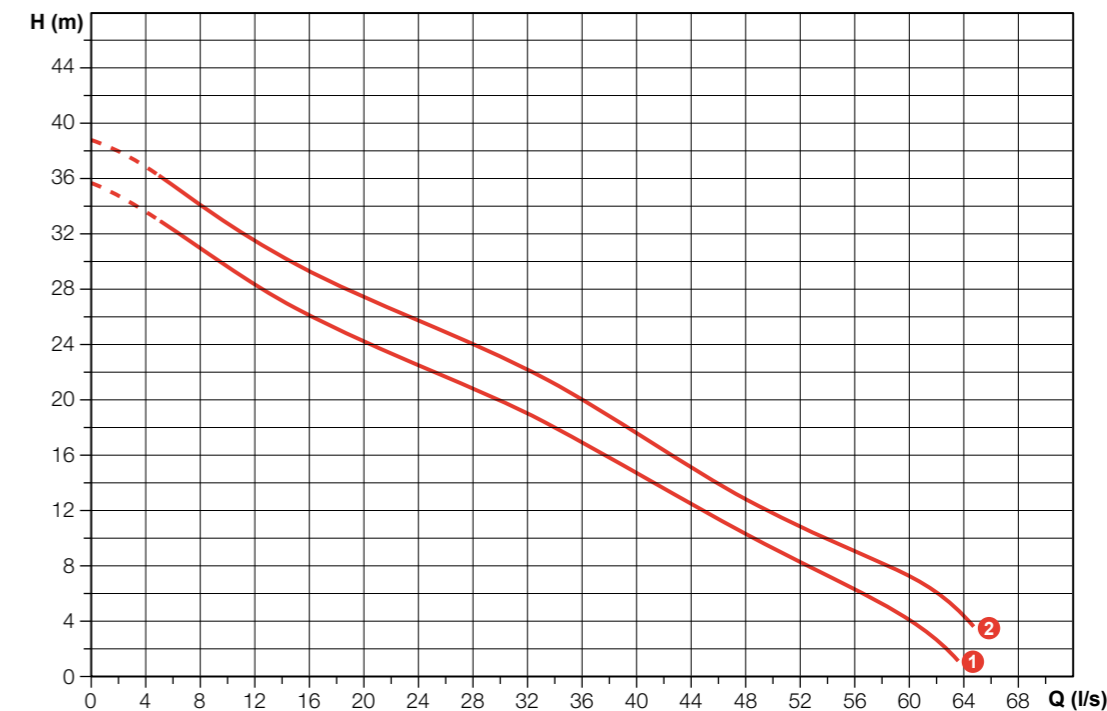

Characteristic curves according to UNI EN ISO 9906

Technical data

	V	Phases	P1 (kW)	P2 (kW)	A	Rpm	Start	Cable	Ø	Free passage	
①	MYB 2000/2/80 W0HT5	400	3	16.9	15.0	26.2	2900	Y Δ	7G1.5+3x1	DN80	45 mm
②	MYB 2500/2/80 W0HT5	400	3	20.7	18.5	32.9	2900	Y Δ	7G2.5+3x1	DN80	45 mm

Technical data

	V	Phases	P1 (kW)	P2 (kW)	A	Rpm	Start	Cable	Ø	Free passage	
①	MYB 1200/2/100 K0GT5	400	3	10.4	9.0	16.1	2900	Y Δ	7G1.5+3x1	DN100	45 mm
②	MYB 1500/2/100 K0GT5	400	3	12.6	11.0	19.5	2900	Y Δ	7G1.5+3x1	DN100	45 mm

MYB 200-300-400/4/80

MYB 550 - 1200/4/80

Performances

	l/s	0	4	8	12	16	20	24	28	32
	l/min	0	240	480	720	960	1200	1440	1680	1920
	m ³ /h	0	14.4	28.8	43.2	57.6	72	86.4	100.8	115.2
1	MYB 200/4/80 M0ET5	8.6	7.7	6.7	5.6	4.4	2.9	1.3		
2	MYB 300/4/80 G0ET5	12.8	11.6	10.2	8.8	7.5	6.3	4.9	3.4	1.6
3	MYB 400/4/80 H0ET5	14.6	13.4	12.0	10.6	9.2	7.8	6.4	4.8	3.0

Performances

	l/s	0	4	8	12	16	20	24	28	32	36	40	44	48	52
	l/min	0	240	480	720	960	1200	1440	1680	1920	2160	2400	2640	2880	3120
	m ³ /h	0	14.4	28.8	43.2	57.6	72	86.4	100.8	115.2	129.6	144	158.4	172.8	187.2
1	MYB 550/4/80 D0FT5	14.1	12.6	12.0	11.5	10.9	10.0	9.1	8.1	7.1	6.1	4.9	3.6	2.1	0.6
2	MYB 750/4/80 D0FT5	18.4	17.0	16.0	15.1	14.3	13.4	12.5	11.5	10.3	9.0	7.7	6.3	4.9	3.5
3	MYB 1000/4/80 D0GT5	22.0	21.0	20.0	19.1	18.3	17.4	16.4	15.3	14.1	12.7	11.3	9.9	8.4	6.9
4	MYB 1200/4/80 D0HT5	24.6	23.2	22.2	21.4	20.6	19.7	18.8	17.7	16.6	15.3	14.0	12.6	1.1	9.6

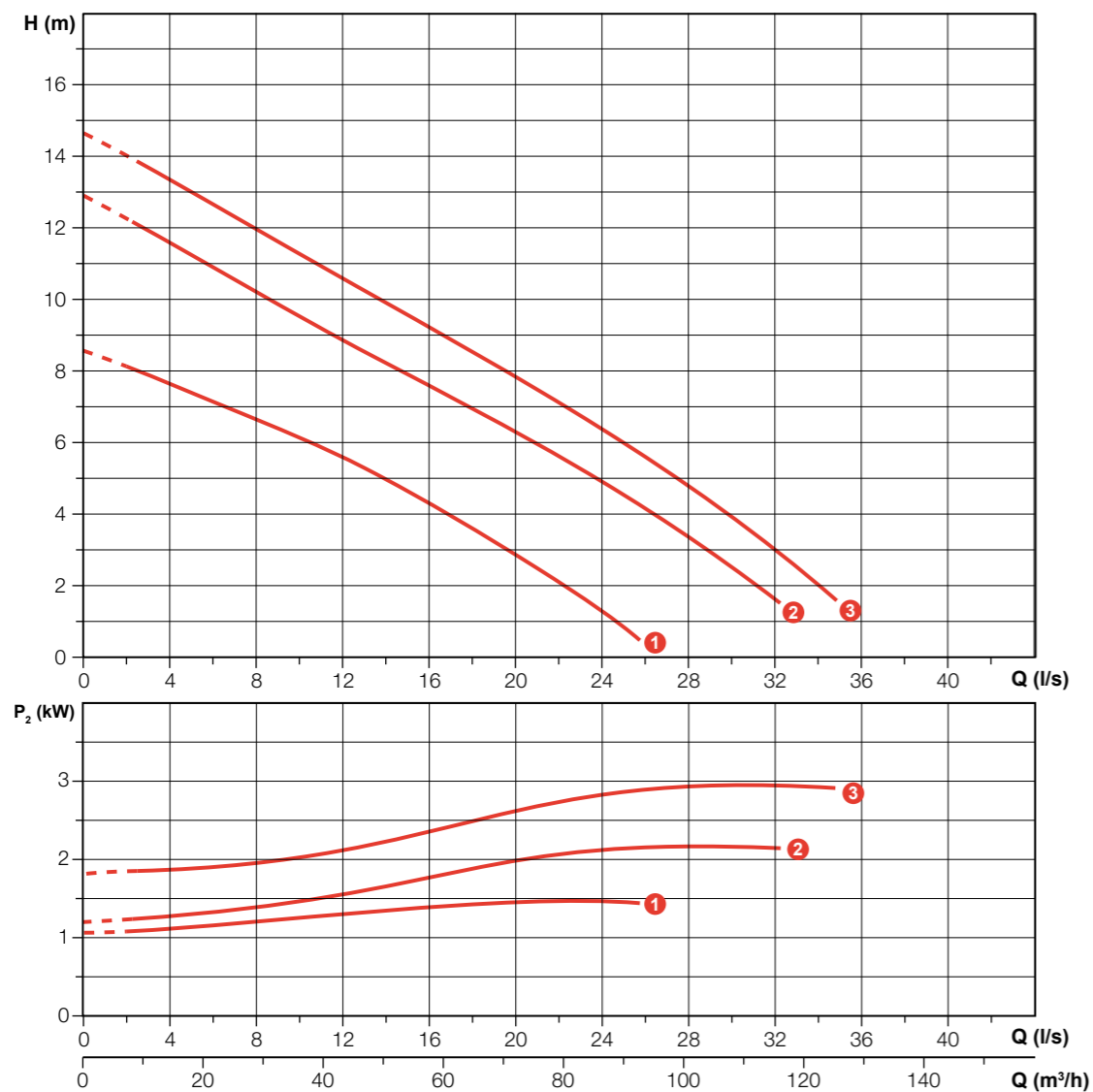

Characteristic curves according to UNI EN ISO 9906

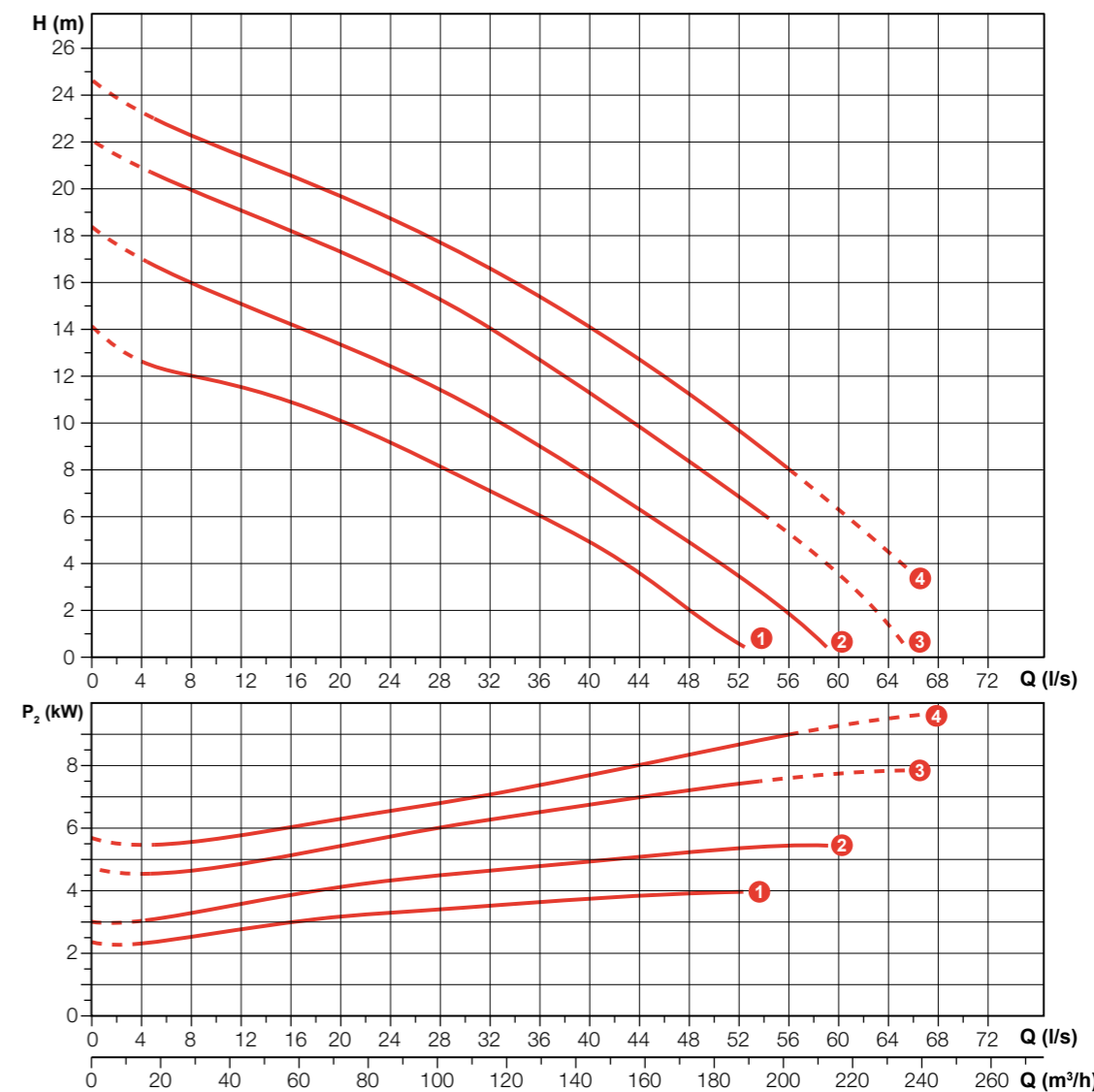

Characteristic curves according to UNI EN ISO 9906

Technical data

	V	Phases	P1 (kW)	P2 (kW)	A	Rpm	Start	Cable	Ø	Free passage	
1	MYB 200/4/80 M0ET5	400	3	1.84	1.5	3.4	1450	Dir	4G1.5+3x1	DN80	45 mm
2	MYB 300/4/80 G0ET5	400	3	2.7	2.2	5.15	1450	Dir	4G1.5+3x1	DN80	75 mm
3	MYB 400/4/80 H0ET5	400	3	3.68	3.0	6.72	1450	Dir	4G1.5+3x1	DN80	75 mm

Technical data

	V	Phases	P1 (kW)	P2 (kW)	A	Rpm	Start	Cable	Ø	Free passage	
1	MYB 550/4/80 D0FT5	400	3	4.62	4.0	8.4	1450	Dir	4G1.5+3x1	DN80	65x60 mm
2	MYB 750/4/80 D0FT5	400	3	6.38	5.5	11.8	1450	Dir	4G1.5+3x1	DN80	65x60 mm
3	MYB 1000/4/80 D0GT5	400	3	8.72	7.5	15.8	1450	Y Δ	7G1.5+3x1	DN80	65x60 mm
4	MYB 1200/4/80 D0HT5	400	3	10.2	9.0	17.0	1450	Y Δ	7G1.5+3x1	DN80	65x60 mm

MYB 200-300-400/4/100

Performances

	l/s	0	4	8	12	16	20	24	28	32	36	40
	l/min	0	240	480	720	960	1200	1440	1680	1920	2160	2400
	m ³ /h	0	14.4	28.8	43.2	57.6	72	86.4	100.8	115.2	129.6	144
1	MYB 200/4/100 T0ET5	8.7	7.9	6.8	5.7	4.7	3.8	2.4	1.2			
2	MYB 300/4/100 U0ET5	9.9	9.2	8.4	7.5	6.6	5.7	4.7	3.5	2.3	1.0	
3	MYB 400/4/100 U0ET5	11.8	11.1	10.2	9.2	8.3	7.3	6.4	5.4	4.3	3.0	1.6

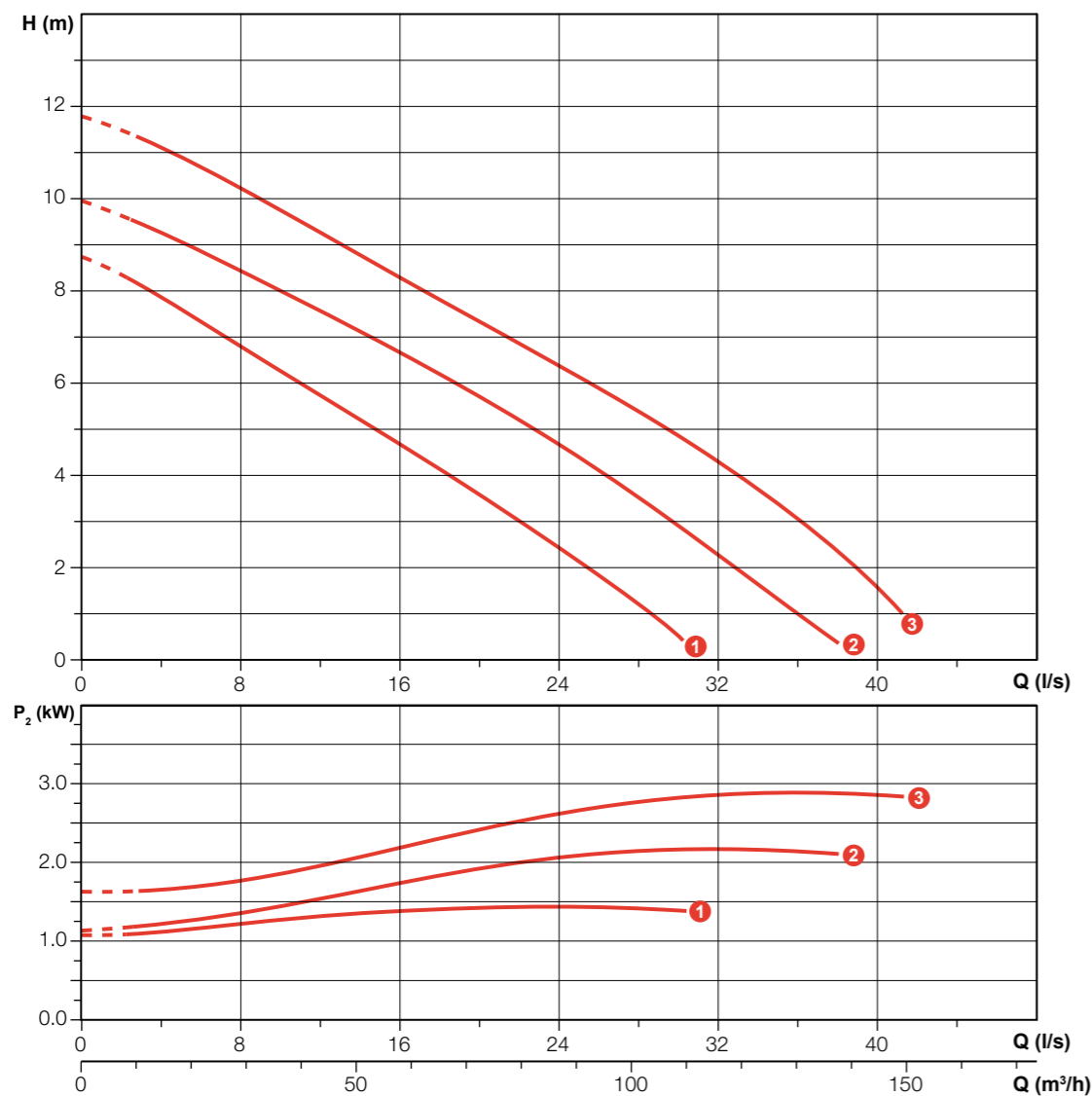

Technical data

	V	Phases	P1 (kW)	P2 (kW)	A	Rpm	Start	Cable	Ø	Free passage	
1	MYB 200/4/100 T0ET5	400	3	1.84	1.5	3.4	1450	Dir	4G1.5+3x1	DN100	45 mm
2	MYB 300/4/100 U0ET5	400	3	2.7	2.2	5.15	1450	Dir	4G1.5+3x1	DN100	60 mm
3	MYB 400/4/100 U0ET5	400	3	3.68	3.0	6.72	1450	Dir	4G1.5+3x1	DN100	60 mm

MYB 300-400/4/100

Performances

	l/s	0	4	8	12	16	20	24	28	32	36
	l/min	0	240	480	720	960	1200	1440	1680	1920	2160
	m ³ /h	0	14.4	28.8	43.2	57.6	72	86.4	100.8	115.2	129.6
1	MYB 300/4/100 X0ET5	12.0	10.6	9.1	7.7	6.6	5.4	4.0	2.5	0.7	
2	MYB 400/4/100 Y0ET5	14.3	13.0	11.4	9.9	8.6	7.4	6.0	4.6	3.0	1.4

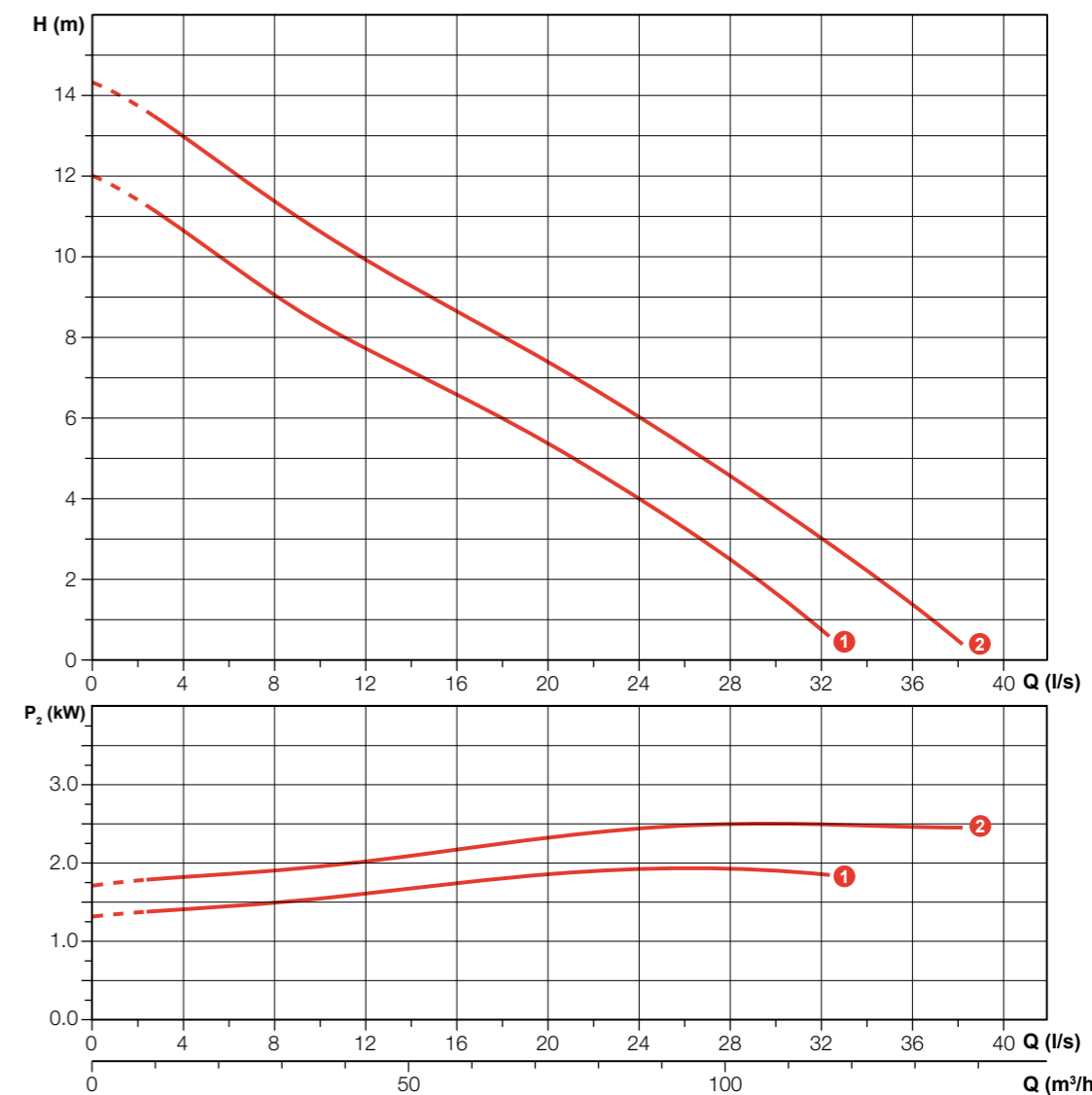

Technical data

	V	Phases	P1 (kW)	P2 (kW)	A	Rpm	Start	Cable	Ø	Free passage	
1	MYB 300/4/100 X0ET5	400	3	2.7	2.2	5.15	1450	Dir	4G1.5+3x1	DN100	75 mm
2	MYB 400/4/100 Y0ET5	400	3	3.68	3.0	6.72	1450	Dir	4G1.5+3x1	DN100	75 mm

MYB 550-750-1000-1200/4/100

Performances

	l/s	0	8	16	24	32	40	48	56	64	72	
	l/min	0	480	960	1440	1920	2400	2880	3360	3840	4320	4800
	m ³ /h	0	28.8	57.6	86.4	115.2	144	172.8	201.6	230.4	259.2	288
①	MYB 550/4/100 ROFT5	15.6	12.5	11.2	10.0	8.8	7.4	5.8	4.2			
②	MYB 750/4/100 LOFT5	16.9	14.7	13.3	11.9	10.4	8.7	7.0	5.0	2.8		
③	MYB 1000/4/100 LOGT5	21.4	19.1	17.6	16.1	14.4	12.5	10.5	8.5	6.2	3.6	
④	MYB 1200/4/100 HOHT5	22.4	20.0	18.0	16.4	14.8	13.3	11.6	9.6	7.2	4.4	1.3

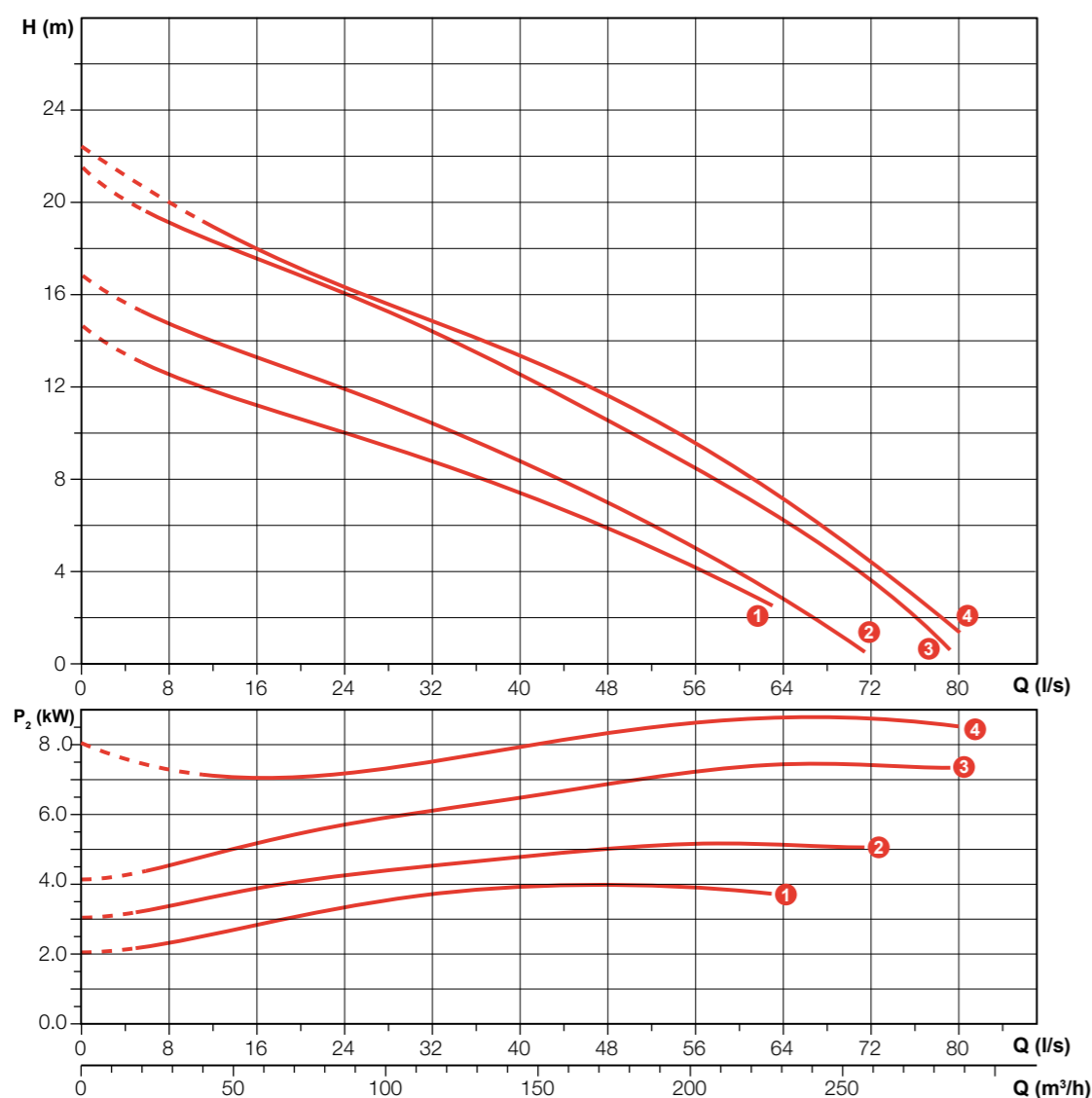

Characteristic curves according to UNI EN ISO 9906

Technical data

	V	Phases	P1 (kW)	P2 (kW)	A	Rpm	Start	Cable	Ø	Free passage	
①	MYB 550/4/100 ROFT5	400	3	4.62	4.0	8.4	1450	Dir	4G1.5+3x1	DN100	65 mm
②	MYB 750/4/100 LOFT5	400	3	6.38	5.5	11.8	1450	Dir	4G1.5+3x1	DN100	65x60 mm
③	MYB 1000/4/100 LOGT5	400	3	8.72	7.5	15.8	1450	Dir	7G1.5+3x1	DN100	65x60 mm
④	MYB 1200/4/100 HOHT5	400	3	10.2	9.0	17	1450	Y Δ	7G1.5+3x1	DN100	80 mm

MYB 1500-2000/4/100

Performances

	l/s	0	8	16	24	32	40	48	56	64	72	80	88	96
	l/min	0	480	960	1440	1920	2400	2880	3360	3840	4320	4800	5280	5760
	m ³ /h	0	28.8	57.6	86.4	115.2	144	172.8	201.6	230.4	259.2	288	316.8	345.6
①	MYB 1500/4/100 AOHT5	18.2	17.5	16.8	15.9	14.8	13.5	12.0	10.4	8.5	6.5	4.0		
②	MYB 2000/4/100 AOHT5	26.6	25.4	23.8	22.0	20.3	18.7	17.1	15.5	13.6	11.5	8.9	5.8	

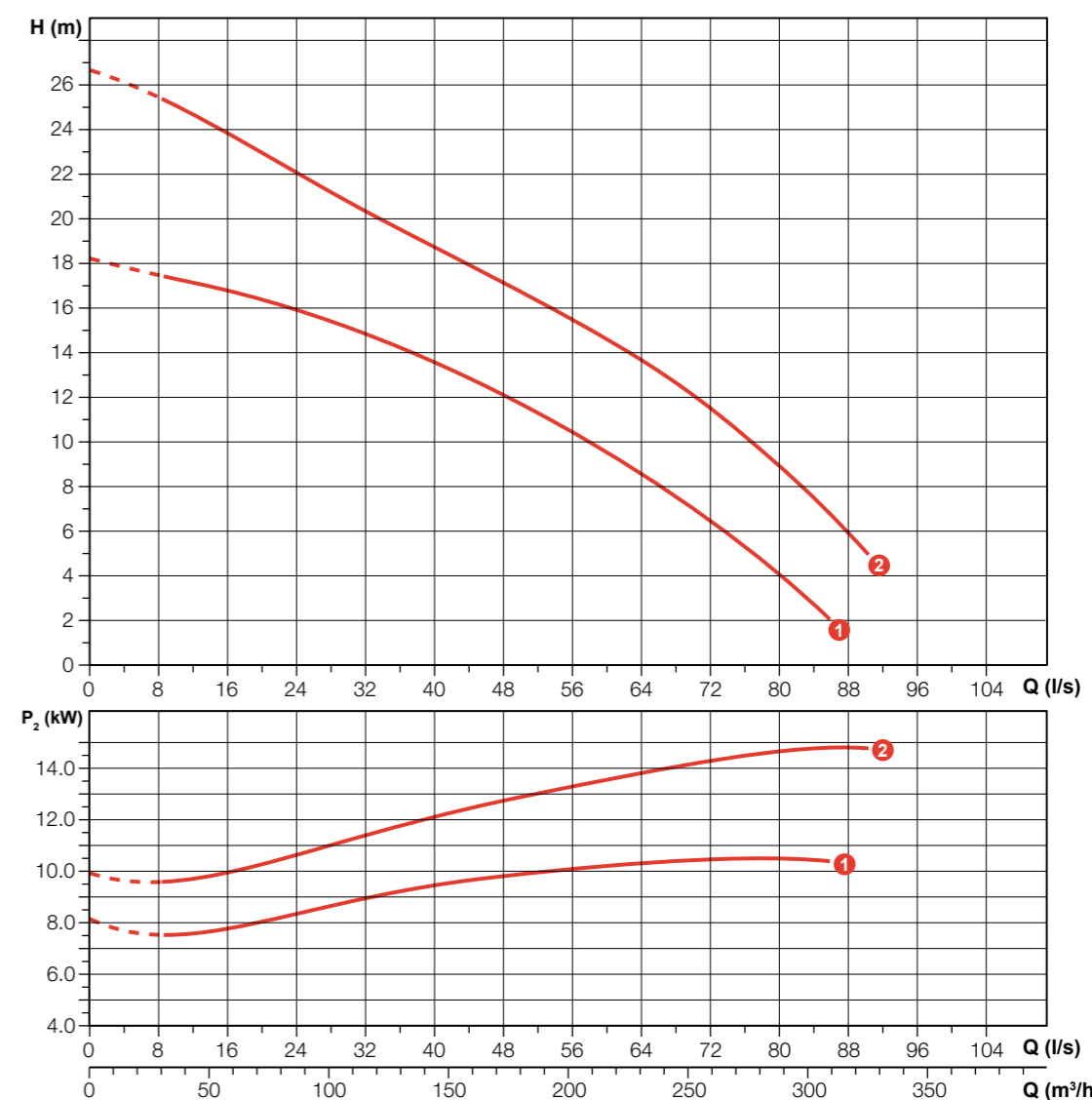

Characteristic curves according to UNI EN ISO 9906

Technical data

	V	Phases	P1 (kW)	P2 (kW)	A	Rpm	Start	Cable	Ø	Free passage	
①	MYB 1500/4/100 AOHT5	400	3	12.6	11.0	20.5	1450	Y Δ	7G1.5+3x1	DN100	80 mm
②	MYB 2000/4/100 AOHT5	400	3	16.7	15.0	30.8	1450	Y Δ	7G2.5+3x1	DN100	80 mm

MYB 1200-2000/4/100

MYB 550-750-1000-1200/4/150

Performances

	l/s	0	8	16	24	32	40	48	56	64	72	80	88	96
	l/min	0	480	960	1440	1920	2400	2880	3360	3840	4320	4800	5280	5760
	m³/h	0	28.8	57.6	86.4	115.2	144	172.8	201.6	230.4	259.2	288	316.8	345.6
①	MYB 1200/4/100 LOHT5	23.1	20.7	19.2	17.7	16.0	14.2	12.2	10.1	7.9	5.3	2.2		
②	MYB 2000/4/100 B0HT5	20.7	20.2	19.4	18.3	17.2	15.9	14.6	13.2	11.7	10.2	8.4	6.5	4.3

Performances

	l/s	0	8	16	24	32	40	48	56	64	72	80	88	96	104
	l/min	0	480	960	1440	1920	2400	2880	3360	3840	4320	4800	5280	5760	6240
	m³/h	0	28.8	57.6	86.4	115.2	144	172.8	201.6	230.4	259.2	288	316.8	345.6	374.4
①	MYB 550/4/150 N0FT5	13.3	11.3	10.3	9.5	8.6	7.5	6.4	5.4	4.2	3.0	1.6			
②	MYB 750/4/150 N0FT5	16.3	14.0	12.7	11.7	10.6	9.5	8.2	7.0	5.7	4.4	3.0	1.4		
③	MYB 1000/4/150 N0GT5	20.8	18.5	16.8	15.5	14.3	13.0	11.7	10.3	8.8	7.2	5.7	4.1	2.3	
④	MYB 1200/4/150 N0HT5	22.5	20.2	18.5	17.1	15.9	14.6	13.2	11.8	10.3	8.7	7.1	5.4	3.7	1.6

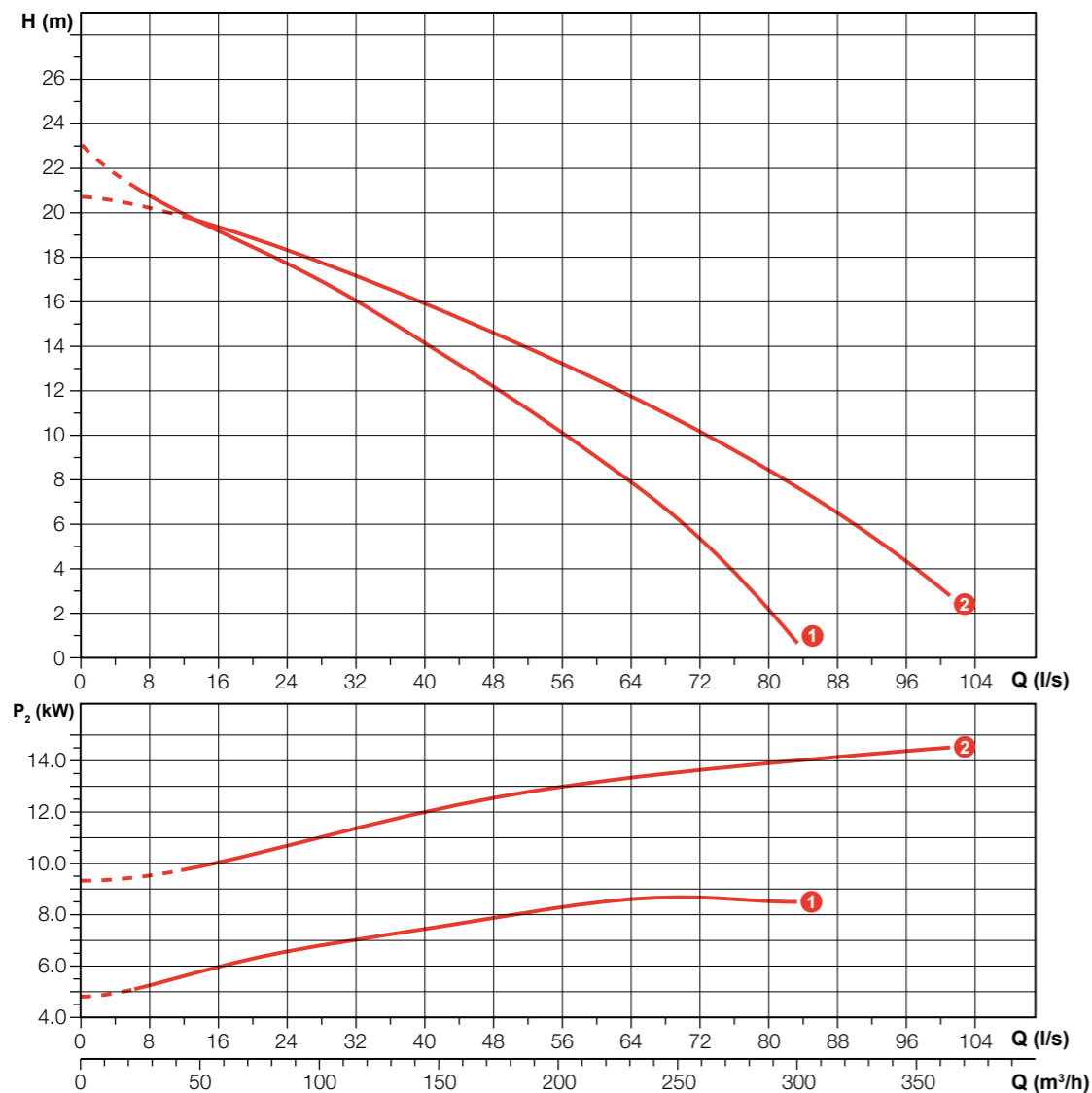

Characteristic curves according to UNI EN ISO 9906

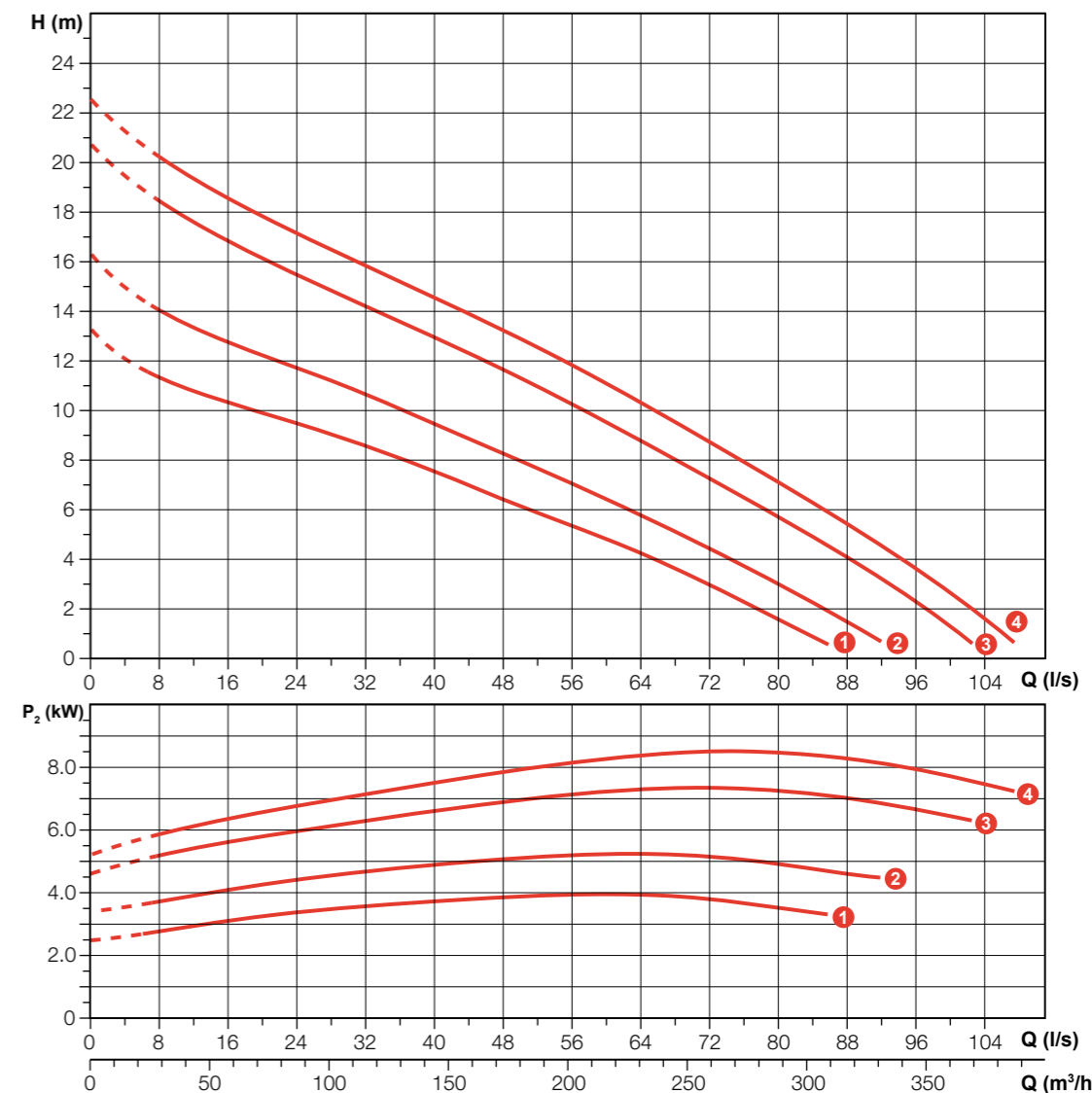

Characteristic curves according to UNI EN ISO 9906

Technical data

	V	Phases	P1 (kW)	P2 (kW)	A	Rpm	Start	Cable	Ø	Free passage	
①	MYB 1200/4/100 LOHT5	400	3	10.2	9.0	17.0	1450	Y Δ	7G1.5+3x1	DN100	65x60
②	MYB 2000/4/100 B0HT5	400	3	16.7	15.0	30.8	1450	Y Δ	7G2.5+3x1	DN100	80 mm

Technical data

	V	Phases	P1 (kW)	P2 (kW)	A	Rpm	Start	Cable	Ø	Free passage	
①	MYB 550/4/150 N0FT5	400	3	4.62	4.0	8.4	1450	Dir	4G1.5+3x1	DN150	65x60
②	MYB 750/4/150 N0FT5	400	3	6.38	5.5	11.8	1450	Dir	4G1.5+3x1	DN150	65x60
③	MYB 1000/4/150 N0GT5	400	3	8.72	7.5	15.8	1450	Y Δ	7G1.5+3x1	DN150	65x60
④	MYB 1200/4/150 N0HT5	400	3	10.2	9.0	17.0	1450	Y Δ	7G1.5+3x1	DN150	65x60

MYB 1200-1500-2000/4/150

MYB 1200-1500-2000/4/200

Performances

l/s	0	12	24	36	48	60	72	84	96	108.0	120.0	132.0
l/min	0	720	1440	2160	2880	3600	4320	5040	5760	6480	7200	7920
m³/h	0	43.2	86.4	129.6	172.8	216	259.2	302.4	345.6	388.8	432	475.2

1 MYB 1200/4/150 A0HT5	13.0	12.6	11.9	10.9	9.9	8.6	7.3	5.9	4.5	2.9	1.3	
2 MYB 1500/4/150 A0HT5	17.1	16.4	15.5	14.3	12.8	11.2	9.5	7.8	6.1	4.4	2.5	
3 MYB 2000/4/150 A0HT5	26.1	23.5	21.4	19.6	18.0	16.6	14.6	12.7	10.5	8.2	5.8	3.4

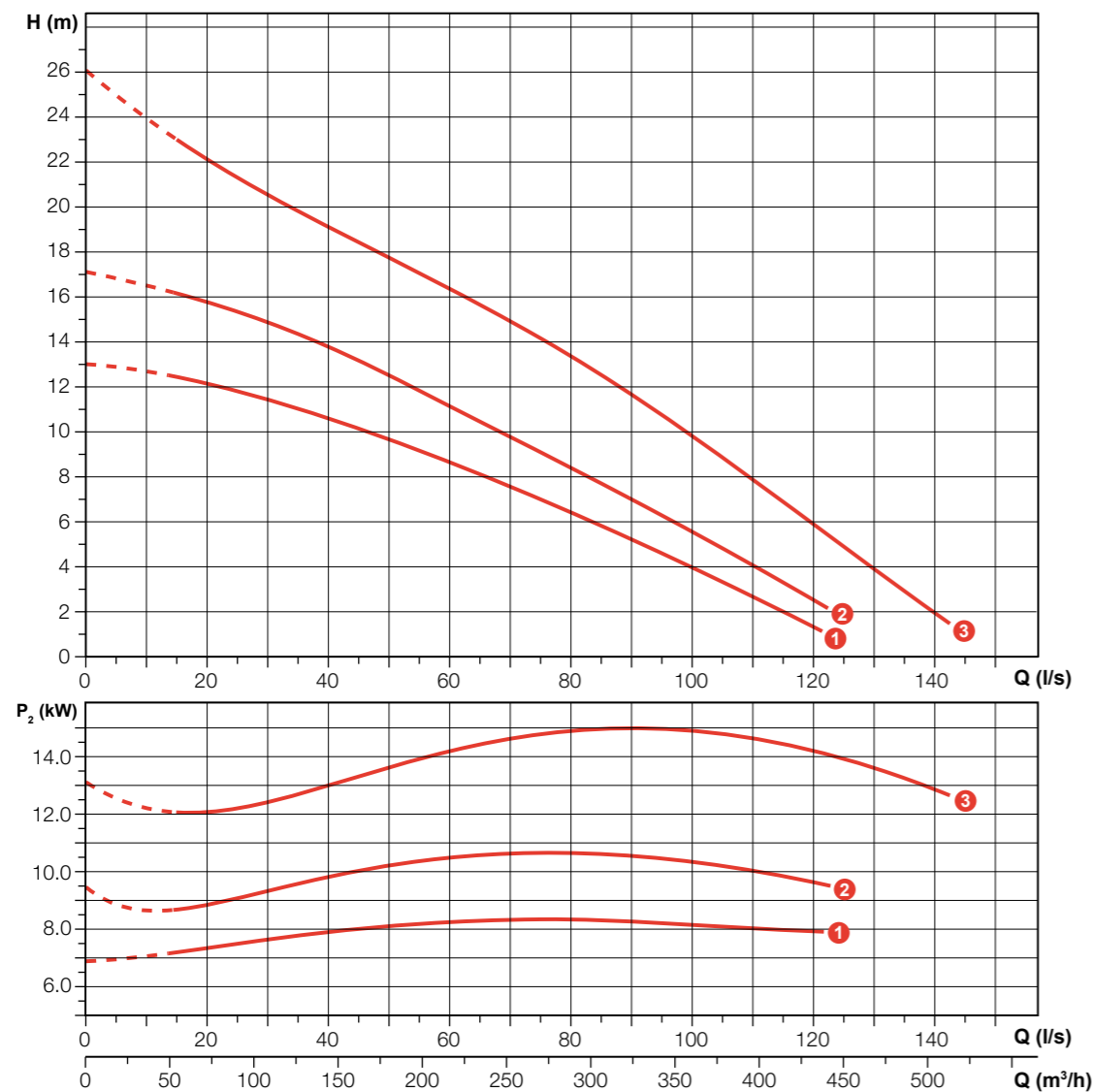

Characteristic curves according to UNI EN ISO 9906

Technical data

	V	Phases	P1 (kW)	P2 (kW)	A	Rpm	Start	Cable	Ø	Free passage
1 MYB 1200/4/150 A0HT5	400	3	10.2	9.0	17	1450	Y Δ	7G1.5+3x1	DN150	80 mm
2 MYB 1500/4/150 A0HT5	400	3	12.6	11.0	20.5	1450	Y Δ	7G1.5+3x1	DN150	80 mm
3 MYB 2000/4/150 A0HT5	400	3	16.7	15.0	30.8	1450	Y Δ	7G2.5+3x1	DN150	80 mm

Performances

l/s	0	16	32	48	64	80	96	112.0	128.0	144.0	160.0
l/min	0	960	1920	2880	3840	4800	5760	6720	7680	8640	9600
m³/h	0	57.6	115.2	172.8	230.4	288	345.6	403.2	460.8	518.4	576

1 MYB 1200/4/200 B0HT5	11.9	11.2	10.3	9.2	8.1	7.0	6.0	5.0	4.0	2.8	1.2
2 MYB 1500/4/200 B0HT5	13.9	13.3	12.1	10.9	9.7	8.6	7.6	6.5	5.2	3.8	2.4
3 MYB 2000/4/200 B0HT5	18.1	17.6	16.4	15.0	13.6	12.2	10.8	9.3	7.7	6.1	4.5

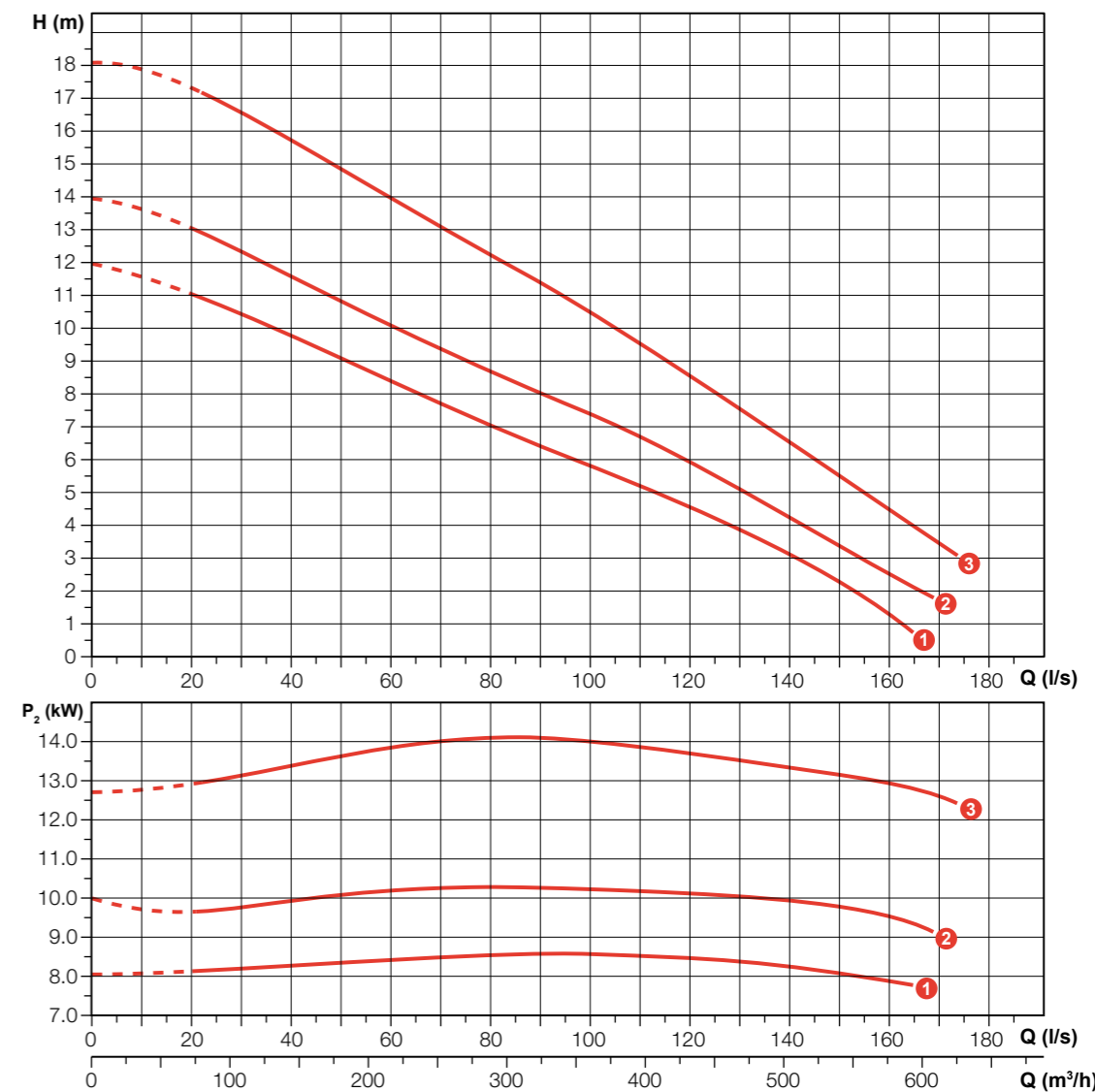

Characteristic curves according to UNI EN ISO 9906

Technical data

	V	Phases	P1 (kW)	P2 (kW)	A	Rpm	Start	Cable	Ø	Free passage
1 MYB 1200/4/200 B0HT5	400	3	10.2	9.0	17.0	1450	Y Δ	7G1.5+3x1	DN200	80 mm
2 MYB 1500/4/200 B0HT5	400	3	12.6	11.0	20.5	1450	Y Δ	7G1.5+3x1	DN200	80 mm
3 MYB 2000/4/200 B0HT5	400	3	16.7	15.0	30.8	1450	Y Δ	7G2.5+3x1	DN200	80 mm

MYB 1200-1500-2000/4/250

MYB 550-750-1000/6/150

Performances

	l/s	0	16	32	48	64	80	96	112.0	128.0	144.0	160.0	176.0	192.0
	l/min	0	960	1920	2880	3840	4800	5760	6720	7680	8640	9600	10560	11520
	m ³ /h	0	57.6	115.2	172.8	230.4	288	345.6	403.2	460.8	518.4	576	633.6	691.2
① MYB 1200/4/250 H0HT5		11.3	10.8	9.9	9.0	8.0	7.2	6.4	5.6	4.7	3.6	2.4	1.3	
② MYB 1500/4/250 H0HT5		13.3	12.7	11.7	10.7	9.7	8.7	7.8	6.9	5.8	4.7	3.4	2.1	
③ MYB 2000/4/250 H0HT5		18.1	16.9	15.7	14.5	13.3	12.2	11	9.8	8.6	7.2	5.7	4.1	2.5

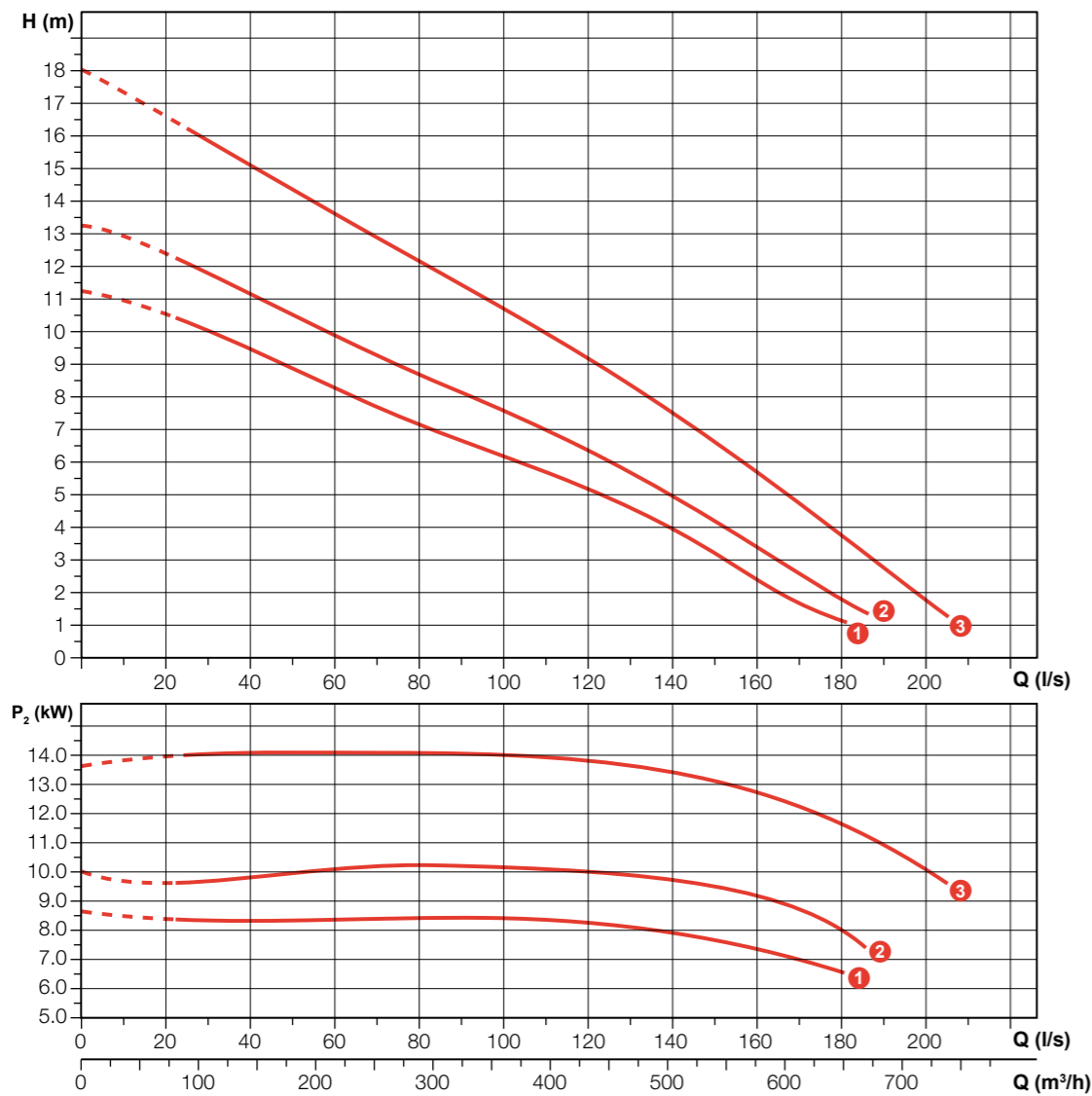

Characteristic curves according to UNI EN ISO 9906

Technical data

	V	Phases	P1 (kW)	P2 (kW)	A	Rpm	Start	Cable	Ø	Free passage
① MYB 1200/4/250 H0HT5	400	3	10.2	9.0	17.0	1450	Y Δ	7G1.5+3x1	DN250	80 mm
② MYB 1500/4/250 H0HT5	400	3	12.6	11.0	20.5	1450	Y Δ	7G1.5+3x1	DN250	80 mm
③ MYB 2000/4/250 H0HT5	400	3	16.7	15.0	30.8	1450	Y Δ	7G2.5+3x1	DN250	80 mm

Performances

	l/s	0	12	24	36	48	60	72	84	96	108.0	120.0
	l/min	0	720	1440	2160	2880	3600	4320	5040	5760	6480	7200
	m ³ /h	0	43.2	86.4	129.6	172.8	216	259.2	302.4	345.6	388.8	432
① MYB 550/6/150 F0GT5		7.9	7.2	6.8	6.1	5.3	4.5	3.7	2.6	1.4		
② MYB 750/6/150 F0GT5		11.9	10.6	9.4	8.5	7.7	6.8	5.7	4.4	3.1	1.4	
③ MYB 1000/6/150 F0HT5		14.8	13.2	12.0	11.0	10.1	9.1	8.0	6.7	5.3	3.9	2.5

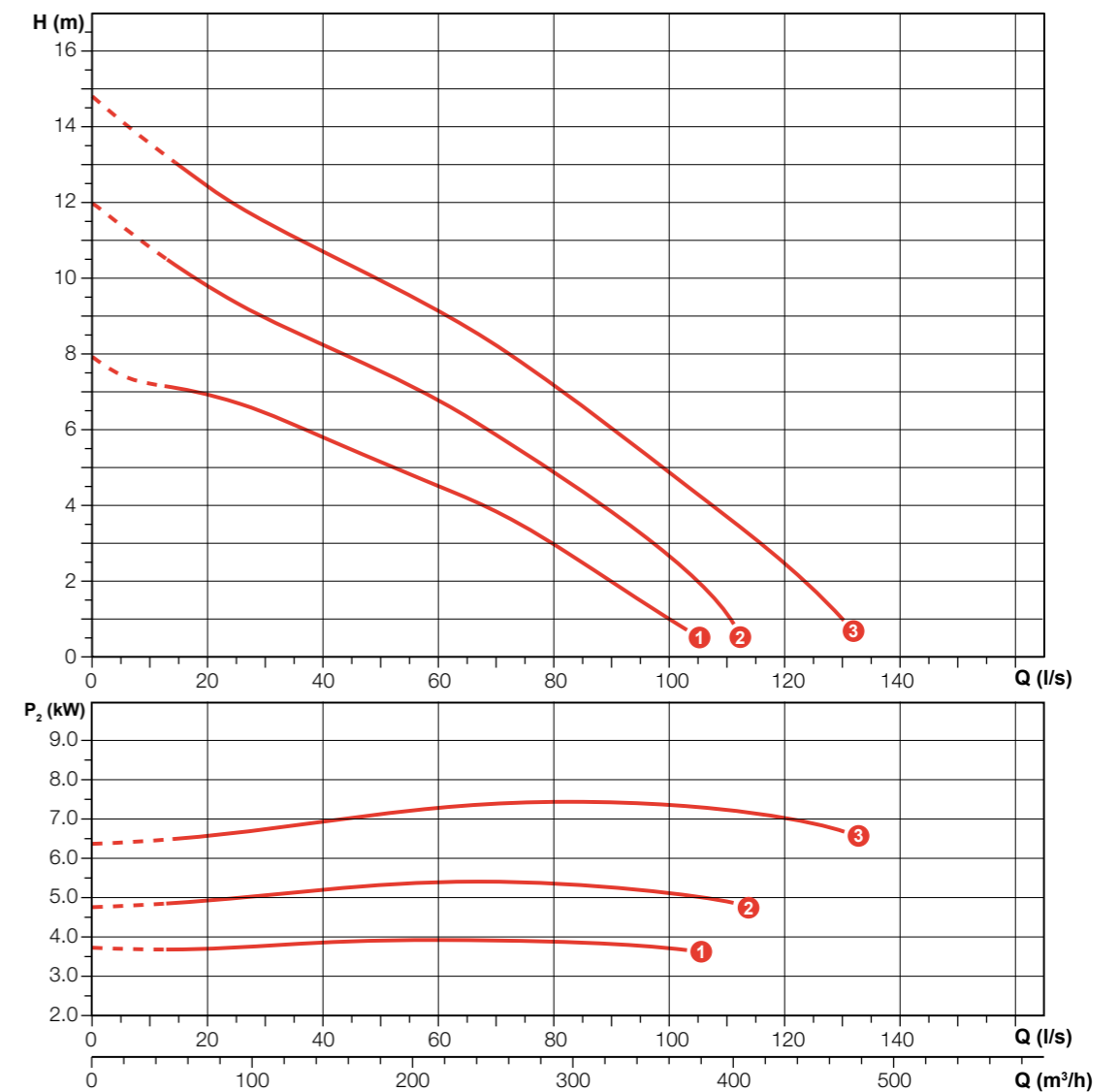

Characteristic curves according to UNI EN ISO 9906

Technical data

	V	Phases	P1 (kW)	P2 (kW)	A	Rpm	Start	Cable	Ø	Free passage
① MYB 550/6/150 F0GT5	400	3	4.91	4.0	9.31	960	Y Δ	7G1.5+3x1	DN150	80 mm
② MYB 750/6/150 F0GT5	400	3	6.62	5.5	12.8	960	Y Δ	7G1.5+3x1	DN150	80 mm
③ MYB 1000/6/150 F0HT5	400	3	8.85	7.5	15.7	960	Y Δ	7G1.5+3x1	DN150	80 mm

MYB 1000-1750/6/200

MYB 1000-1750/6/250

Performances

	l/s	0	16	32	48	64	80	96	112.0	128.0	144.0	160.0
	l/min	0	960	1920	2880	3840	4800	5760	6720	7680	8640	9600
	m ³ /h	0	57.6	115.2	172.8	230.4	288	345.6	403.2	460.8	518.4	576
①	MYB 1000/6/200 A0HT5	12.2	10.9	10.1	9.0	7.7	6.4	5.1	3.9	2.5		
②	MYB 1000/6/200 B0HT5	14.4	12.4	10.9	9.7	8.4	7.0	5.6	4.3	2.6		
③	MYB 1750/6/200 A0HT5	17.2	16.1	14.9	13.8	12.5	11.2	9.8	8.4	6.9	5.2	3.4

Performances

	l/s	0	16	32	48	64	80	96	112.0	128.0	144.0	160.0	176.0	192.0
	l/min	0	960	1920	2880	3840	4800	5760	6720	7680	8640	9600	10560	11520
	m ³ /h	0	57.6	115.2	172.8	230.4	288	345.6	403.2	460.8	518.4	576	633.6	691.2
①	MYB 1000/6/250 C0HT5	11.5	10.5	9.7	8.9	7.8	6.6	5.5	4.5	3.4	2.1			
②	MYB 1000/6/250 H0HT5	13.6	11.6	10.3	9.3	8.3	7.3	6.0	4.7	3.4	2.0			
③	MYB 1750/6/250 C0HT5	16.5	15.4	14.4	13.3	12.2	11.1	10.0	8.8	7.5	6.1	4.6	3.1	1.4

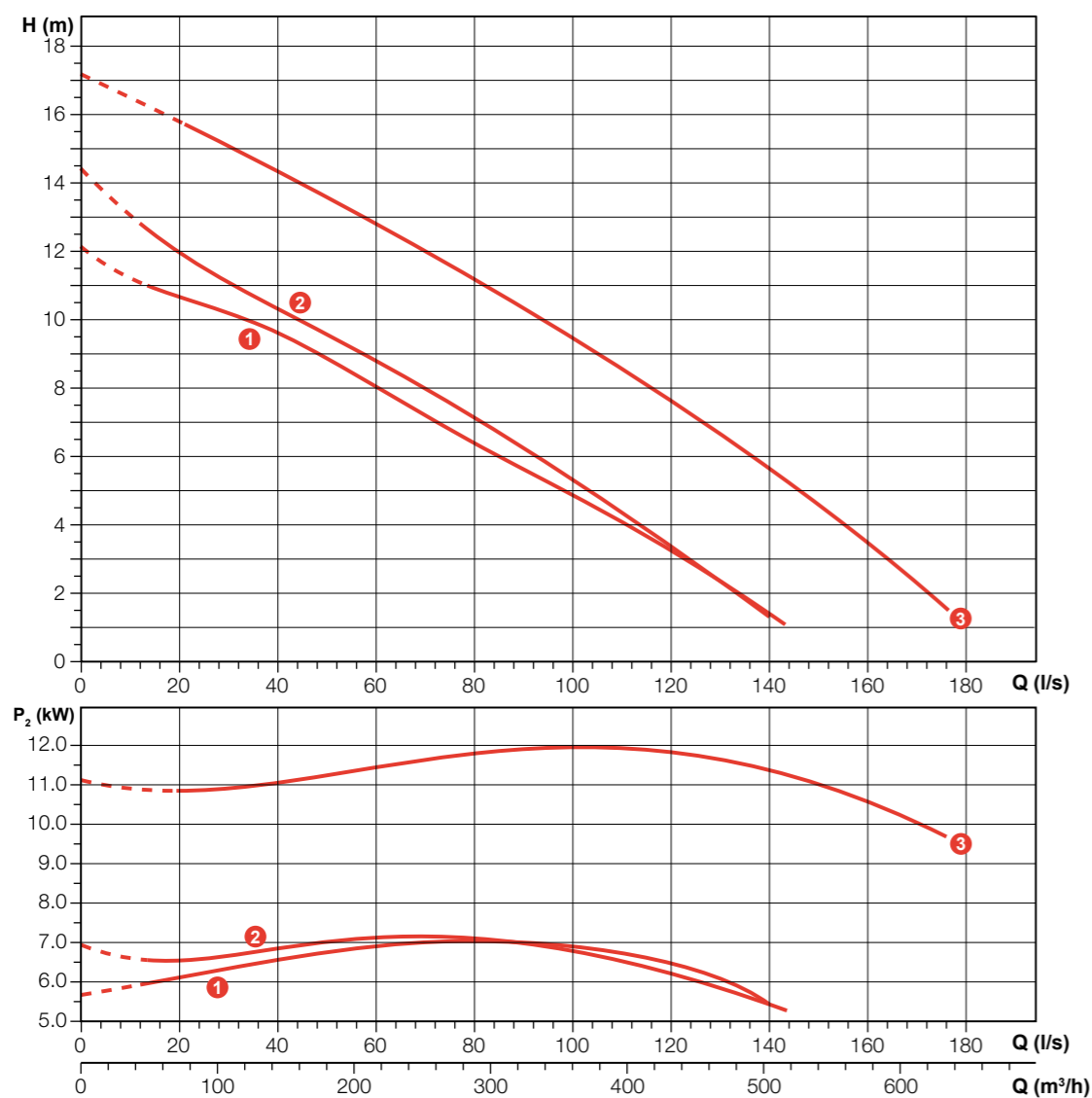

Characteristic curves according to UNI EN ISO 9906

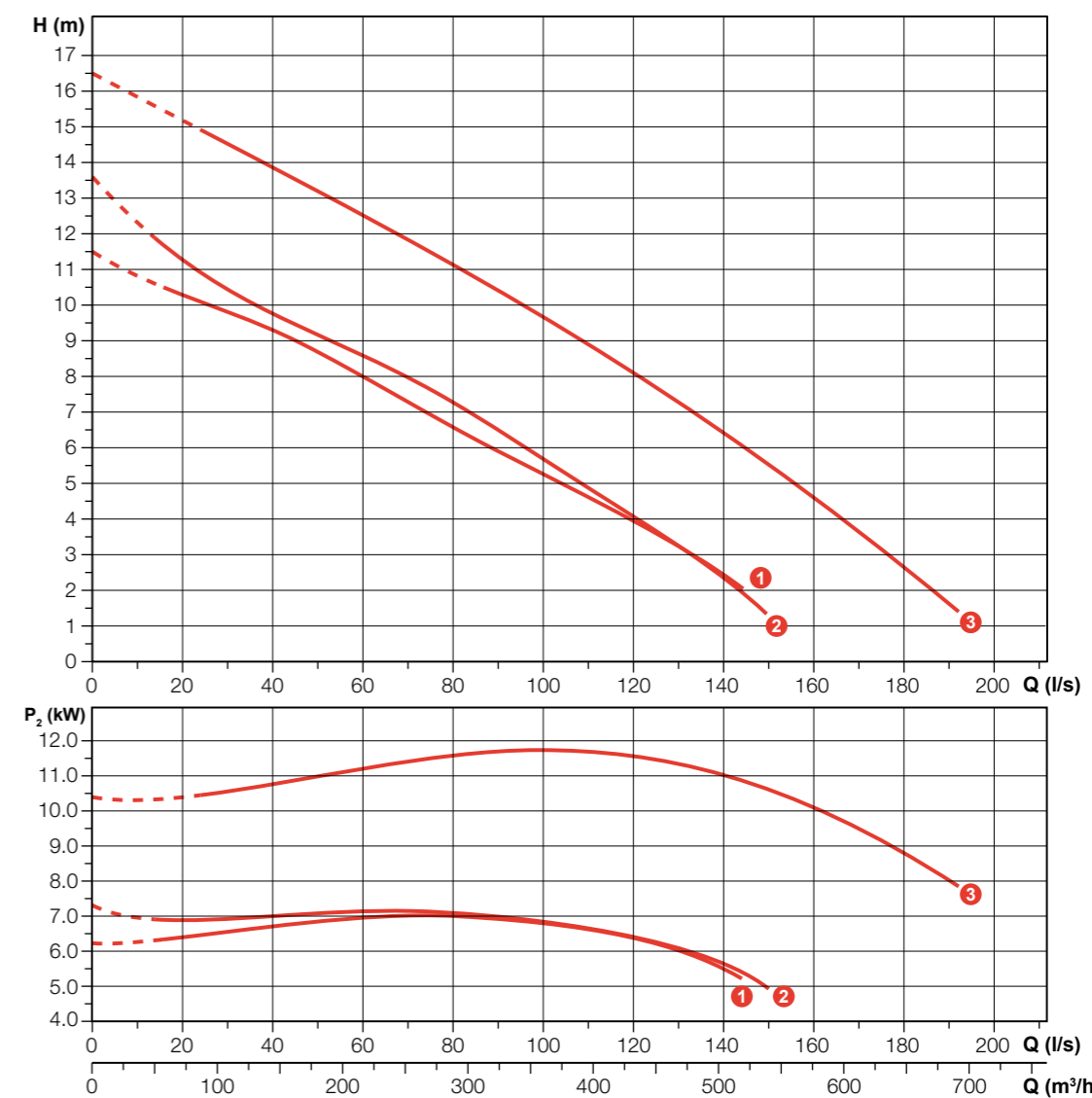

Characteristic curves according to UNI EN ISO 9906

Technical data

	V	Phases	P1 (kW)	P2 (kW)	A	Rpm	Start	Cable	Ø	Free passage	
①	MYB 1000/6/200 A0HT5	400	3	8.85	7.5	15.7	960	Y Δ	7G1.5+3x1	DN200	100x70 mm
②	MYB 1000/6/200 B0HT5	400	3	8.85	7.5	15.7	960	Y Δ	7G1.5+3x1	DN200	80 mm
③	MYB 1750/6/200 A0HT5	400	3	15.0	13.0	27.6	960	Y Δ	7G2.5+3x1	DN200	100x70 mm

Technical data

	V	Phases	P1 (kW)	P2 (kW)	A	Rpm	Start	Cable	Ø	Free passage	
①	MYB 1000/6/250 C0HT5	400	3	8.85	7.5	15.7	960	Dir	7G1.5+3x1	DN250	100x70 mm
②	MYB 1000/6/250 H0HT5	400	3	8.85	7.5	15.7	960	Dir	7G1.5+3x1	DN250	80 mm
③	MYB 1750/6/250 C0HT5	400	3	15.0	13.0	27.6	960	Dir	7G2.5+3x1	DN250	100x70 mm

MYB

MYB

Overall dimensions and weights

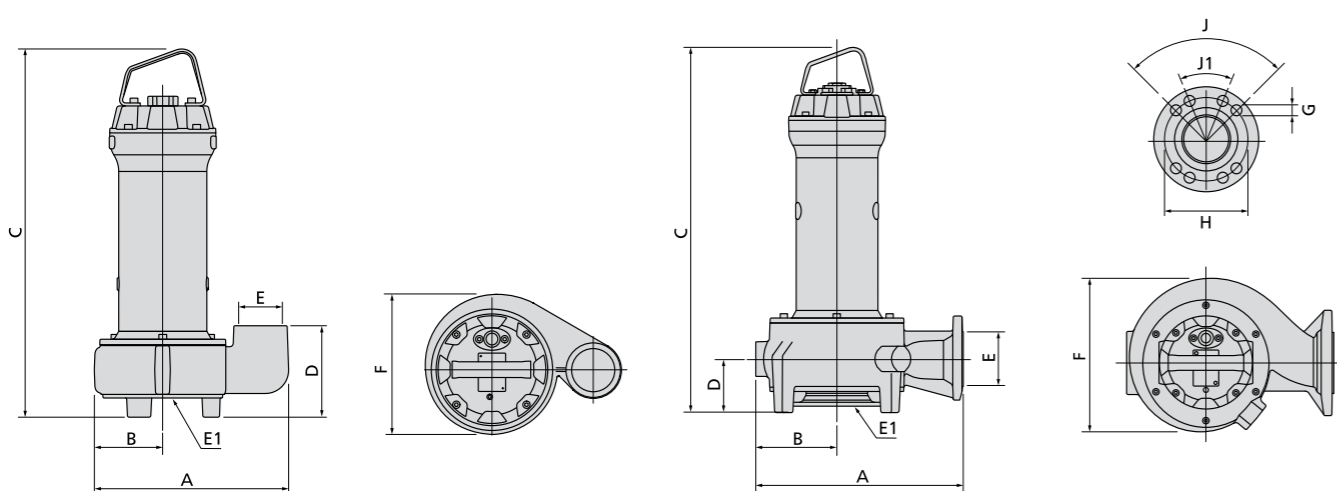

	A	B	C	D	E	E1	F	kg
MYB 250/2/G65V B0AT5	327	116	541	153	2½"	65	240	33.0
MYB 300/2/G65V A0ET5	327	116	565	153	2½"	65	240	42.2
MYB 400/2/G65V A0ET5	327	116	615	153	2½"	65	240	45.0

	A	B	C	D	E	E1	F	G	H	J°	J1°	kg
MYB 150/2/65 B0AT5	344	136	543	80	65	65	255	18	145	90	-	33.5
MYB 200/2/65 B0AT5	344	136	543	80	65	65	255	18	145	90	-	34.0
MYB 250/2/65 B0AT5	344	136	543	80	65	65	255	18	145	90	-	34.0
MYB 300/2/65 A0ET5	344	136	565	80	65	65	255	18	145	90	-	59.6
MYB 400/2/65 A0ET5	344	136	615	80	65	65	255	18	145	90	-	61.6
MYB 550/2/65 C0FT5	343	136	698	88	65	65	253	18	145	90	-	63.6
MYB 250/2/80 L0AT5	347	135	542	80	80	80	252	18	160	90	45	36.0
MYB 300/2/80 E0ET5	347	135	564	80	80	80	252	18	160	90	45	60.6
MYB 400/2/80 E0ET5	347	135	614	80	80	80	252	18	160	90	45	62.6
MYB 550/2/80 B0FT5	327	142	707	91	80	80	271	18	160	90	45	68.0
MYB 550/2/80 P0FT5	343	136	698	88	80	80	253	18	160	90	45	63.6
MYB 750/2/80 A0FT5	327	142	707	91	80	80	271	18	160	90	45	70.7
MYB 750/2/80 B0FT5	327	142	707	91	80	80	271	18	160	90	45	70.7
MYB 1000/2/80 A0FT5	327	142	782	91	80	80	271	18	160	90	45	79.7
MYB 1000/2/80 B0FT5	327	142	782	91	80	80	271	18	160	90	45	79.7
MYB 1200/2/80 A0GT5	327	142	850	91	80	80	271	18	160	90	45	110.0
MYB 1200/2/80 B0GT5	327	142	850	91	80	80	271	18	160	90	45	110.0
MYB 1500/2/80 A0GT5	327	142	850	91	80	80	271	18	160	90	45	113.0
MYB 1500/2/80 B0GT5	327	142	850	91	80	80	271	18	160	90	45	113.0
MYB 2000/2/80 G0HT5	393	151	930	88	80	80	293	18	160	90	45	155.0
MYB 2000/2/80 W0HT5	481	188	980	124	80	150	360	18	160	90	45	183.0
MYB 2500/2/80 G0HT5	393	151	1033	88	80	80	293	18	160	90	45	165.0
MYB 2500/2/80 W0HT5	481	188	1070	124	80	150	360	18	160	90	45	193.0
MYB 200/4/80 M0ET5	394	151	603	88	80	80	292	18	160	90	45	66.0
MYB 300/4/80 G0ET5	393	151	653	88	80	80	292	18	160	90	45	72.6
MYB 400/4/80 H0ET5	393	151	653	88	80	80	291	18	160	90	45	77.0
MYB 550/4/80 D0FT5	481	188	831	124	80	150	367	18	160	90	45	108.8
MYB 750/4/80 D0FT5	481	188	831	124	80	150	367	18	160	90	45	109.8
MYB 1000/4/80 D0GT5	481	188	899	124	80	150	367	18	160	90	45	141.0
MYB 1200/4/80 D0HT5	481	188	980	124	80	150	367	18	160	90	45	199.0

Dimensions in mm

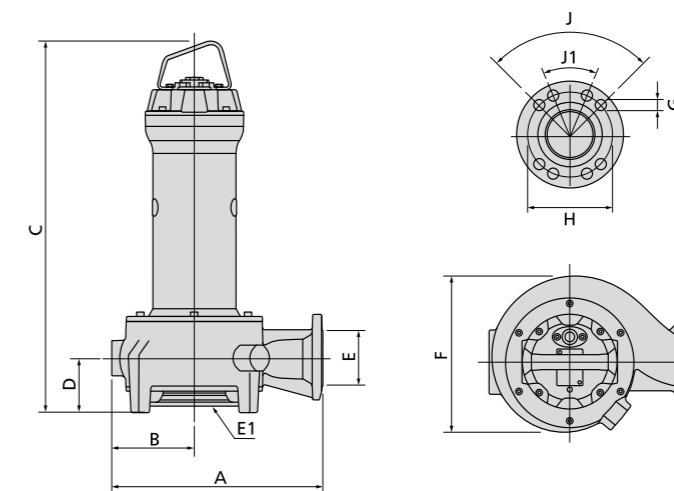

	A	B	C	D	E	E1	F	G	H	J°	J1°	kg
MYB 200/4/100 T0ET5	417	160	603	91	100	100	310	18	180	45	-	69.0
MYB 300/4/100 U0ET5	417	160	653	91	100	100	310	18	180	45	-	75.6
MYB 300/4/100 X0ET5	417	160	653	91	100	100	310	18	180	45	-	63.2
MYB 400/4/100 U0ET5	417	160	653	91	100	100	310	18	180	45	-	80.0
MYB 400/4/100 Y0ET5	417	160	653	91	100	100	310	18	180	45	-	64.8
MYB 550/4/100 R0FT5	449	183	780	91	100	100	353	18	180	45	-	88.8
MYB 750/4/100 L0FT5	552	212	832	124	100	150	400	18	180	45	-	112.2
MYB 1000/4/100 L0GT5	552	212	900	124	100	150	400	18	180	45	-	143.0
MYB 1200/4/100 H0HT5	548	208	979	124	100	150	413	18	180	45	-	211.0
MYB 1200/4/100 L0HT5	552	212	980	124	100	150	400	18	180	45	-	185.0
MYB 1500/4/100 A0HT5	548	208	979	124	100	100	413	18	180	45	-	222.0
MYB 2000/4/100 A0HT5	548	208	1069	124	100	100	413	18	180	45	-	227.1
MYB 2000/4/100 B0HT5	590	240	1072	121	100	100	471	18	180	45	-	228.1
MYB 550/4/150 N0FT5	616	227	838	130	150	150	449	24	240	45	-	120.0
MYB 750/4/150 N0FT5	616	227	838	130	150	150	449	24	240	45	-	120.2
MYB 1000/4/150 N0GT5	616	227	905	130	150	150	449	24	240	45	-	151.0
MYB 1200/4/150 A0HT5	612	222	985	130	150	150	447	24	240	45	-	228.1
MYB 1200/4/150 N0HT5	616	227	985	130	150	150	449	24	240	45	-	193.0
MYB 1500/4/150 A0HT5	612	222	985	130	150	150	447	24	240	45	-	234.0
MYB 2000/4/150 A0HT5	612	222	1075	130	150	150	447	24	240	45	-	240.0
MYB 1200/4/200 B0HT5	692	273	1046	172	200	200	539	24	295	45	-	255.0
MYB 1500/4/200 B0HT5	692	273	1136	172	200	200	539	24	295	45	-	261.0
MYB 2000/4/200 B0HT5	692	273	1136	172	200	200	539	24	295	45	-	267.0
MYB 1200/4/250 H0HT5	808	334	1046	203	250	200	609	24	350	30	-	286.0
MYB 1500/4/250 H0HT5	808	334	1136	203	250	200	609	24	350	30	-	292.0
MYB 2000/4/250 H0HT5	808	334	1136	203	250	200	609	24	350	30	-	298.0
MYB 550/6/150 F0GT5	647	252	1015	172	150	200	507	24	350	30	-	193.0
MYB 750/6/150 F0GT5	647	252	1015	172	150	200	507	24	350	30	-	195.0
MYB 1000/6/150 F0HT5	647	252	1047	172	150	200	507	24	350	30	-	235.0
MYB 1000/6/200 A0HT5	692	273	1077	203	200	250	539	24	295	45	-	298.8
MYB 1000/6/200 B0HT5	692	273	1046	172	200	200	539	24	295	45	-	261.0
MYB 1750/6/200 A0HT5	692	273	1167	203	200	250	539	24	295	45	-	308.8
MYB 1000/6/250 C0HT5	808	334	1078	203	250	250	609	24	350	30	-	324.3
MYB 1000/6/250 H0HT5	808	334	1046	203	250	200	609	24	350	30	-	292.0
MYB 1750/6/250 C0HT5	808	334	1168	203	250	250	609	24	350	30	-	334.3

Dimensions in mm

MYB

MYU

Packaging dimension



	X	Y	Z
MYB 250/2/G65V B0AT5	445	725	425
MYB 300/2/G65V A0ET5	445	725	425
MYB 400/2/G65V A0ET5	445	725	425
MYB 150/2/65 B0AT5	445	725	425
MYB 200/2/65 B0AT5	445	725	425
MYB 250/2/65 B0AT5	445	725	425
MYB 300/2/65 A0ET5	445	725	425
MYB 400/2/65 A0ET5	445	725	425
MYB 550/2/65 C0FT5	445	725	425
MYB 250/2/80 L0AT5	445	725	425
MYB 300/2/80 E0ET5	445	725	425
MYB 400/2/80 E0ET5	445	725	425
MYB 550/2/80 B0FT5	445	725	425
MYB 550/2/80 P0FT5	445	725	425
MYB 750/2/80 A0FT5	445	725	425
MYB 750/2/80 B0FT5	445	725	425
MYB 1000/2/80 A0FT5	535	915	560
MYB 1000/2/80 B0FT5	535	915	560
MYB 1200/2/80 A0GT5	535	915	560
MYB 1200/2/80 B0GT5	535	915	560
MYB 1500/2/80 A0GT5	535	915	560
MYB 1500/2/80 B0GT5	535	915	560
MYB 2000/2/80 G0HT5	535	1000	560
MYB 2000/2/80 W0HT5	535	915	560
MYB 2500/2/80 G0HT5	725	1270	675
MYB 2500/2/80 W0HT5	725	1270	675
MYB 1200/2/100 K0GT5	535	915	560
MYB 1500/2/100 K0GT5	535	915	560
MYB 200/4/80 M0ET5	445	725	425
MYB 300/4/80 G0ET5	445	725	425
MYB 400/4/80 H0ET5	445	725	425
MYB 550/4/80 D0FT5	535	915	560
MYB 750/4/80 D0FT5	535	915	560
MYB 1000/4/80 D0GT5	535	915	560
MYB 1200/4/80 D0HT5	725	1270	675

	X	Y	Z
MYB 200/4/100 T0ET5	445	725	425
MYB 300/4/100 U0ET5	445	725	425
MYB 300/4/100 X0ET5	445	725	425
MYB 400/4/100 U0ET5	445	725	425
MYB 400/4/100 Y0ET5	445	725	425
MYB 550/4/100 R0FT5	535	915	560
MYB 750/4/100 L0FT5	725	1270	675
MYB 1000/4/100 L0GT5	725	1270	675
MYB 1200/4/100 H0HT5	725	1270	675
MYB 1200/4/100 L0HT5	725	1270	675
MYB 1500/4/100 A0HT5	725	1270	675
MYB 2000/4/100 A0HT5	725	1270	675
MYB 2000/4/100 B0HT5	725	1270	675
MYB 550/4/150 N0FT5	725	1270	675
MYB 750/4/150 N0FT5	725	1270	675
MYB 1000/4/150 N0GT5	725	1270	675
MYB 1200/4/150 A0HT5	725	1270	675
MYB 1200/4/150 N0HT5	725	1270	675
MYB 1500/4/150 A0HT5	725	1270	675
MYB 2000/4/150 A0HT5	725	1270	675
MYB 1200/4/200 B0HT5	725	1270	675
MYB 1500/4/200 B0HT5	725	1270	675
MYB 2000/4/200 B0HT5	725	1270	675
MYB 1200/4/250 H0HT5	825	1070	1355
MYB 1500/4/250 H0HT5	825	1070	1355
MYB 2000/4/250 H0HT5	825	1070	1355
MYB 550/6/150 F0GT5	725	1270	675
MYB 750/6/150 F0GT5	725	1270	675
MYB 1000/6/150 F0HT5	725	1270	675
MYB 1000/6/200 A0HT5	725	1270	675
MYB 1000/6/200 B0HT5	725	1270	675
MYB 1750/6/200 A0HT5	725	1270	675
MYB 1000/6/250 C0HT5	825	1070	1355
MYB 1000/6/250 H0HT5	825	1070	1355
MYB 1750/6/250 C0HT5	825	1070	1355

Dimensions in mm

Vortex impeller

Operating ranges

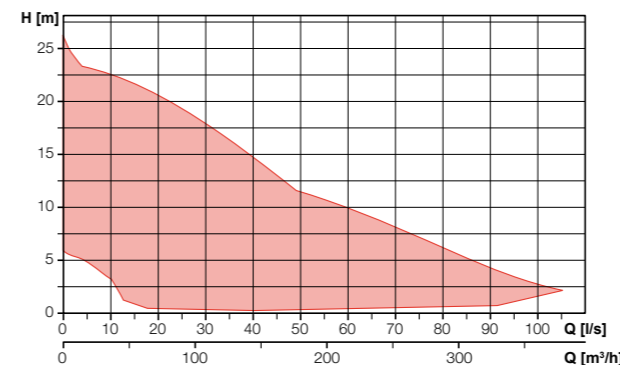

Range characteristics

Motor power	1.8 - 15.0 kW
Poles	2 / 4
Insulation class	H
Degree of protection	IP68
Discharge	GAS 2 1/2" vertical DN65 - DN150 horizontal
Free passage	max 125 mm
Max flow rate	106 l/s
Max head	26.1 m

Motor

Ecological dry motor with thermal protections

Cable

S1RN8-F electric cable. Standard version 10 m cable length

Mechanical seals

Two silicon carbide (SiC) mechanical seals in oil sump.

Applications

Used with unstrained soiled biological wastewaters and sewage and for civil lifting applications. It is thus ideal for wastewater treatment plants, sewer systems, livestock farms, industry and agriculture

Installations

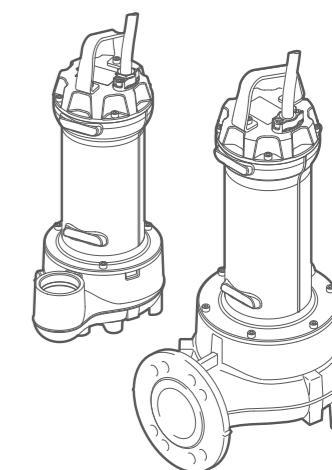
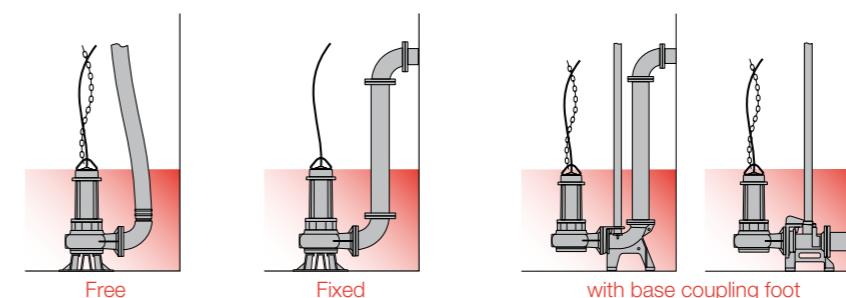

Versions

Electrical variants	NAE, TS
Cooling system	N
Mechanical seals	2SIC

Operating specifications

Max operating temperature	40 °C
PH of treated fluid	6 - 14
Viscosity of treated fluid	1 mm²/s
Maximum immersion depth	20 m
Density of treated fluid	1 Kg/dm³
Acoustic pressure max	<70dB
Max starts per hour	30

Construction materials

Case	Cast iron EN-GJL 250
Hydraulic parts	Cast iron EN-GJL 250
Impeller	Cast iron EN-GJL 250
Nuts and bolts	Stainless steel - Class A2-70
Standard gasket	Rubber - NBR
Shaft	Stainless steel - AISI 431
Paint type	Ecological bicomponent epoxy (~ 200 µm)

MYU 250-300/2/G65V

MYU 250-1000/2/65

Performances

	l/s	0	2	4	6	8	10	12	14
	l/min	0	120	240	360	480	600	720	840
	m ³ /h	0	7.2	14.4	21.6	28.8	36.0	43.2	50.4
① MYU 250/2/G65V B0AT5		13.0	11.2	8.7	6.5	4.8	3.4	2.0	
② MYU 300/2/G65V A0ET5		15.0	13.1	10.9	8.7	6.7	4.9	3.4	1.9

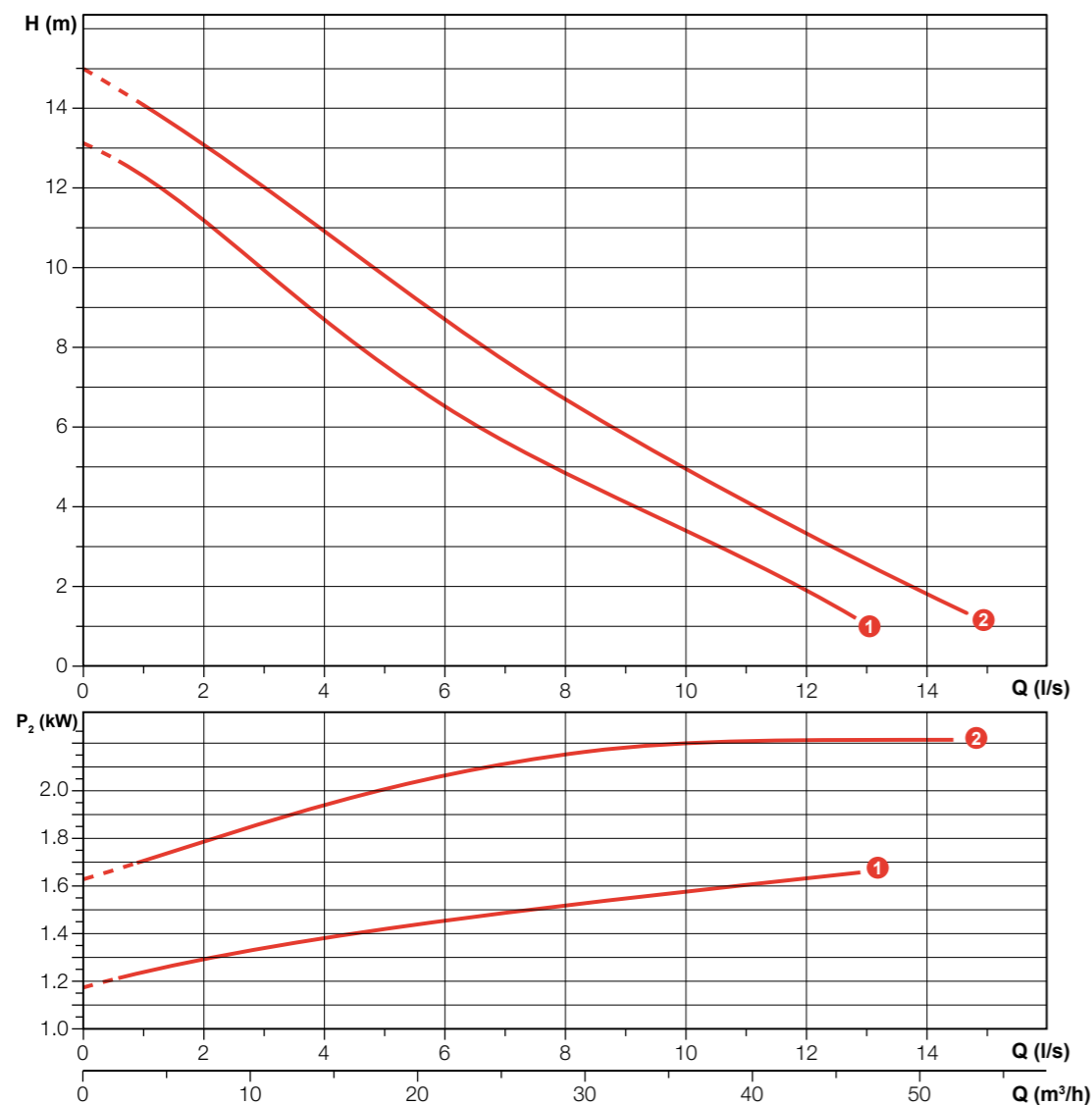

Characteristic curves according to UNI EN ISO 9906

Technical data

	V	Phases	P1 (kW)	P2 (kW)	A	Rpm	Start	Cable	Ø	Free passage
① MYU 250/2/G65V B0AT5	400	3	2.19	1.8	3.7	2900	Dir	4G1	G 2½"	65 mm
② MYU 300/2/G65V A0ET5	400	3	2.76	2.2	4.62	2900	Dir	4G1.5+3x1	G 2½"	65 mm

80 mm discharge bore available

Performances

	l/s	0	2	4	6	8	10	12	14	16	18	20	22	24	26
	l/min	0	120	240	360	480	600	720	840	960	1080	1200	1320	1440	1560
	m ³ /h	0	7.2	14.4	21.6	28.8	36.0	43.2	50.4	57.6	64.8	72.0	79.2	86.4	93.6
① MYU 250/2/65 B0AT5		13.0	11.3	9.0	6.9	5.2	3.8	2.7	1.6						
② MYU 300/2/65 C0ET5		15.1	13.4	11.0	9.1	7.4	5.6	3.9	2.6						
③ MYU 400/2/65 D0ET5		17.7	16.4	14.5	12.2	9.9	7.7	5.8	4.2	2.9					
④ MYU 550/2/65 A0FT5		19.5	18.4	17.0	15.4	13.6	11.7	9.8	7.9	6.1	4.4	2.9			
⑤ MYU 750/2/65 A0FT5		22.3	21.2	19.9	18.6	17.0	15.3	13.5	11.6	9.8	7.9	6.2	4.7		
⑥ MYU 1000/2/65 A0FT5		26.1	24.4	23.3	22.4	21.4	20.2	18.7	17.0	15.3	13.5	11.8	10.3	8.7	6.8

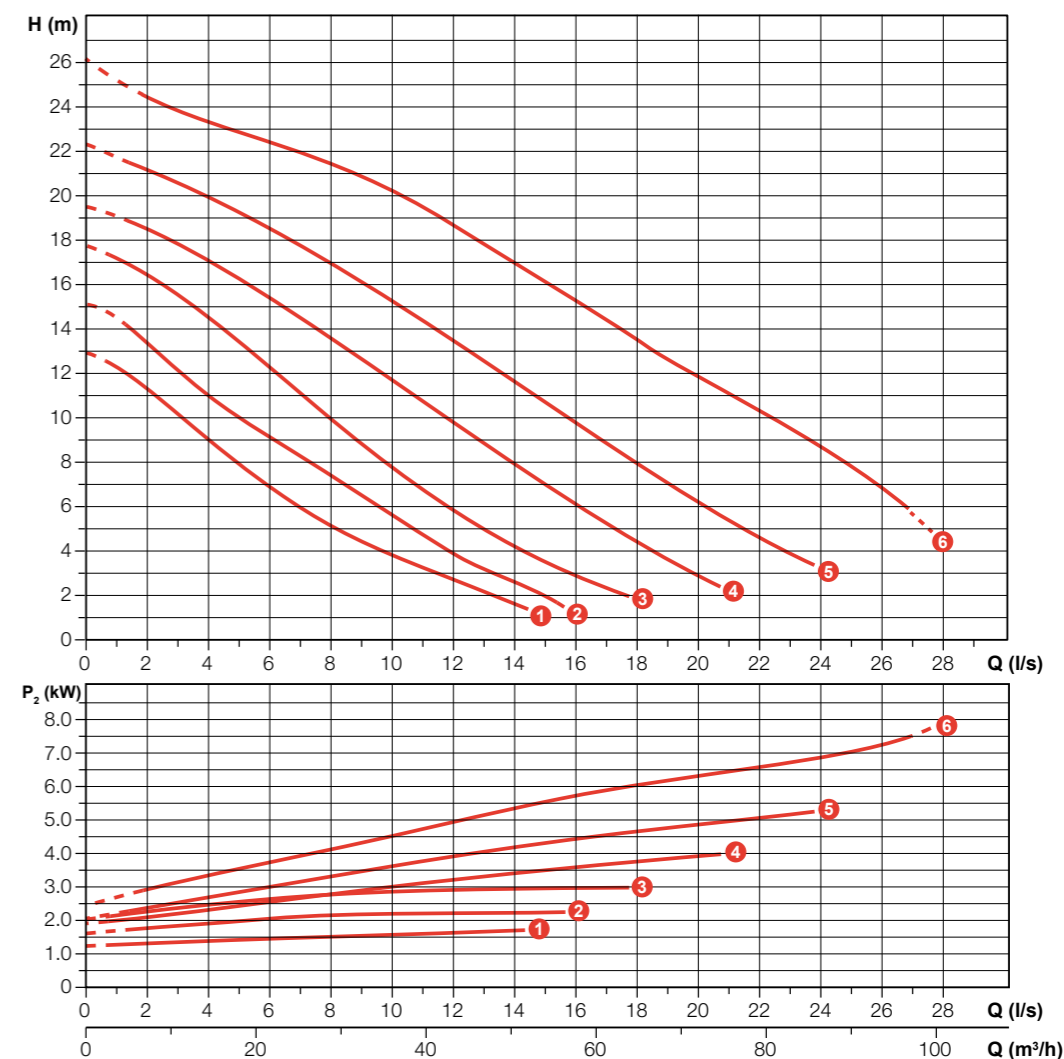

Characteristic curves according to UNI EN ISO 9906

Technical data

	V	Phases	P1 (kW)	P2 (kW)	A	Rpm	Start	Cable	Ø	Free passage
① MYU 250/2/65 B0AT5	400	3	2.19	1.8	3.7	2900	Dir	4G1	DN65	65 mm
② MYU 300/2/65 C0ET5	400	3	2.76	2.2	4.62	2900	Dir	4G1.5+3x1	DN65	65 mm
③ MYU 400/2/65 D0ET5	400	3	3.68	3.0	3.36	2900	Dir	4G1.5+3x1	DN65	65 mm
④ MYU 550/2/65 A0FT5	400	3	4.66	4.0	7.73	2900	Dir	4G1.5+3x1	DN65	65 mm
⑤ MYU 750/2/65 A0FT5	400	3	6.32	5.5	10.8	2900	Dir	4G1.5+3x1	DN65	65 mm
⑥ MYU 1000/2/65 A0FT5	400	3	8.51	7.5	13.7	2900	Dir	4G1.5+3x1	DN65	65 mm

80 mm discharge bore available

MYU 250 - 1000/2/80

MYU 150 - 400/4/65

Performances

l/s	0	4	8	12	16	20	24	28	32	36
l/min	0	240	480	720	960	1200	1440	1680	1920	2160
m³/h	0	14.4	28.8	43.2	57.6	72.0	86.4	100.8	115.2	129.6

1 MYU 250/2/80 FOAT5	7.9	5.7	4.0	2.9	1.9					
2 MYU 300/2/80 GOET5	9.7	6.7	5.6	4.2	2.6					
3 MYU 400/2/80 HOET5	12.8	10.1	7.1	4.7	3.1	1.4				
4 MYU 550/2/80 NOFT5	17.5	15.0	12.4	8.9	5.9	3.9				
5 MYU 750/2/80 AOFT5	17.1	15.1	12.9	10.5	7.8	5.3	3.2	1.7		
6 MYU 1000/2/80 AOFT5	21.6	20.0	17.7	15.1	12.4	9.6	7.1	4.8	3.0	1.8

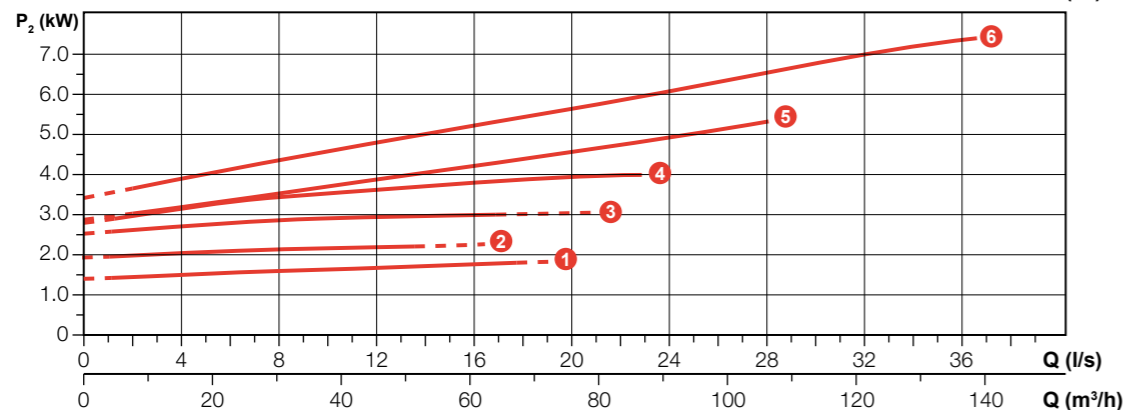
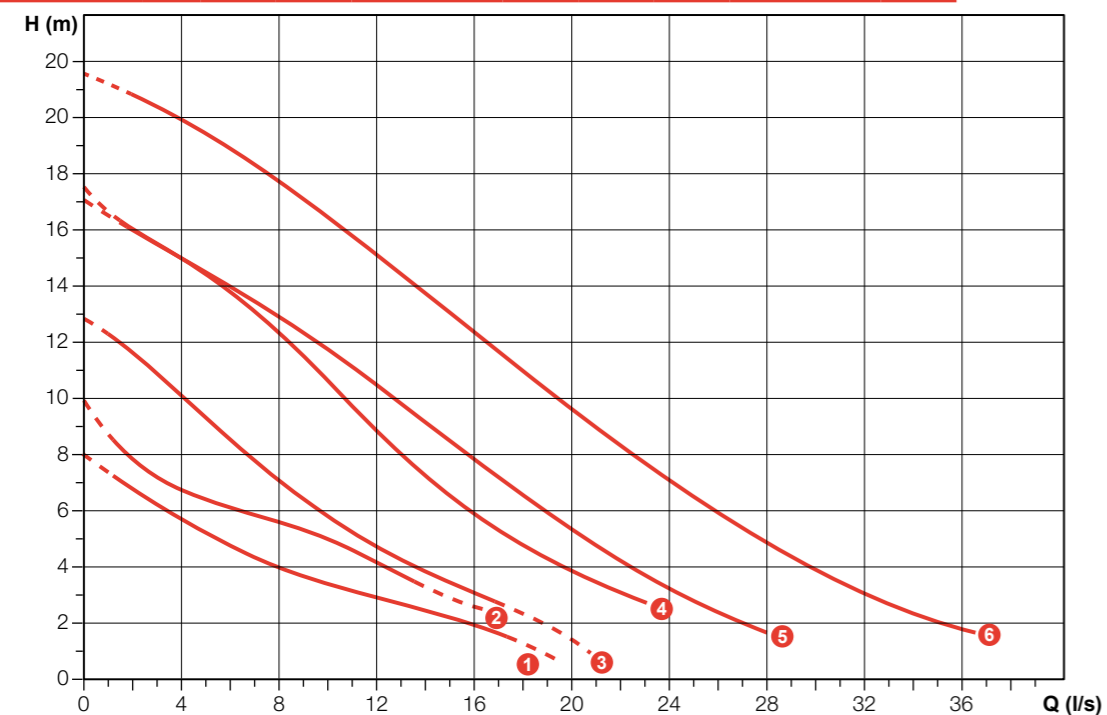

Technical data

	V	Phases	P1 (kW)	P2 (kW)	A	Rpm	Start	Cable	Ø	Free passage
1 MYU 250/2/80 FOAT5	400	3	2.19	1.8	3.7	2900	Dir	4G1	DN80	80 mm
2 MYU 300/2/80 GOET5	400	3	2.76	2.2	4.62	2900	Dir	4G1.5+3x1	DN80	80 mm
3 MYU 400/2/80 HOET5	400	3	3.68	3.0	6.36	2900	Dir	4G1.5+3x1	DN80	80 mm
4 MYU 550/2/80 NOFT5	400	3	4.66	4.0	7.73	2900	Dir	4G1.5+3x1	DN80	80 mm
5 MYU 750/2/80 AOFT5	400	3	6.32	5.5	10.8	2900	Dir	4G1.5+3x1	DN80	80 mm
6 MYU 1000/2/80 AOFT5	400	3	8.51	7.5	13.7	2900	Dir	4G1.5+3x1	DN80	80 mm

Performances

l/s	0	2	4	6	8	10	12	14	16	18	20	22
l/min	0	120	240	360	480	600	720	840	960	1080	1200	1320
m³/h	0	7.2	14.4	21.6	28.8	36.0	43.2	50.4	57.6	64.8	72.0	79.2

1 MYU 150/4/65 HOAT5	7.5	7.2	6.6	5.8	4.6	3.4	2.4	1.6				
2 MYU 200/4/65 FOET5	10.4	9.8	9.2	8.4	7.4	6.3	5.0	3.6	2.0			
3 MYU 250/4/65 FOET5	11.3	10.8	10.2	9.5	8.6	7.5	6.2	4.7	3.2			
4 MYU 300/4/65 FOET5	12.2	11.6	11.0	10.4	9.6	8.7	7.6	6.3	4.8	3.2		
5 MYU 400/4/65 GOET5	12.8	12.2	11.5	10.9	10.3	9.7	9.0	8.2	7.3	6.3	5.3	4.0

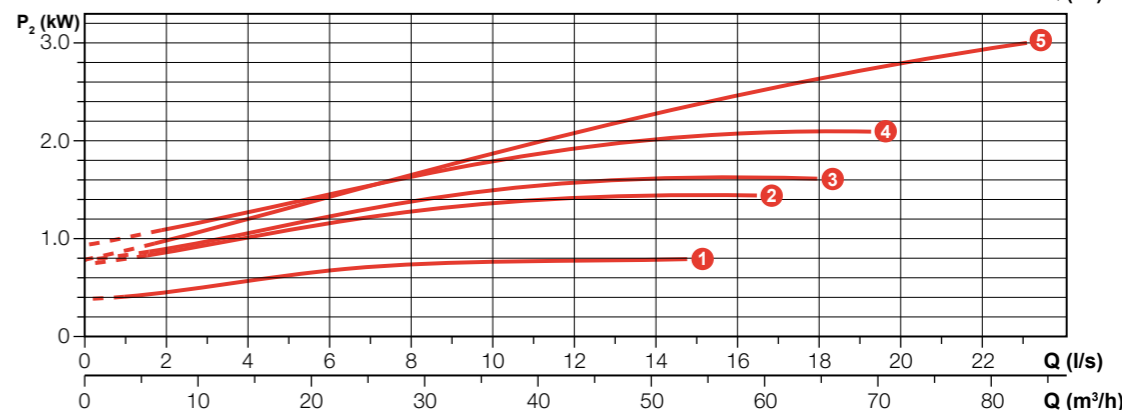
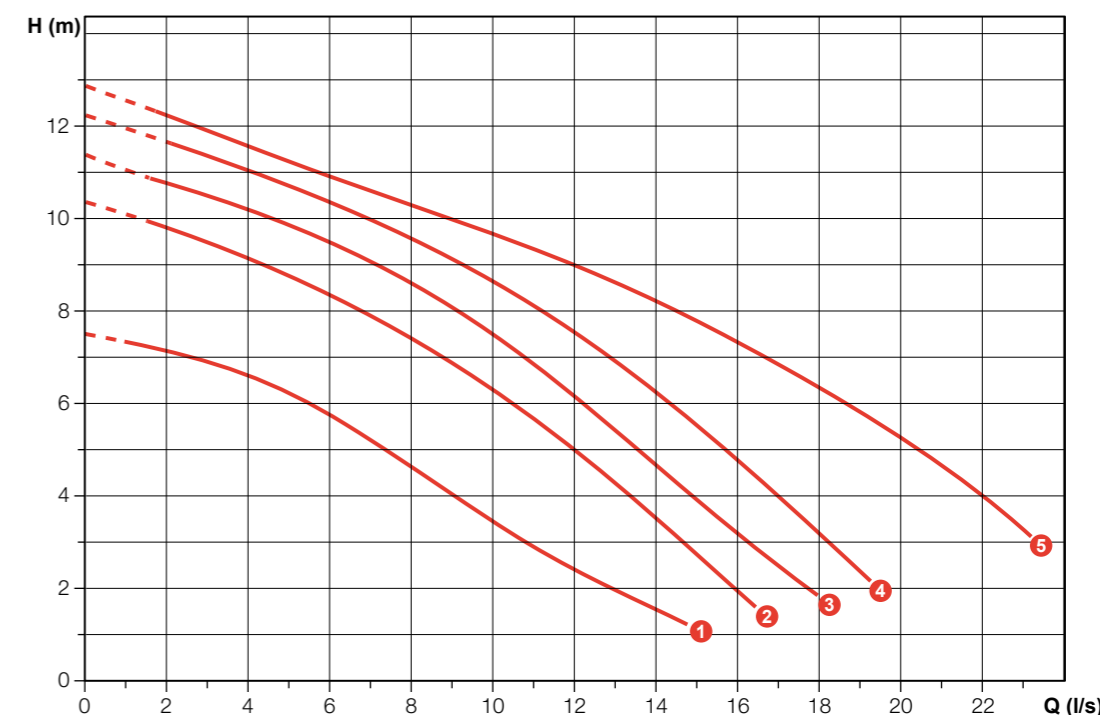

Technical data

	V	Phases	P1 (kW)	P2 (kW)	A	Rpm	Start	Cable	Ø	Free passage
1 MYU 150/4/65 HOAT5	400	3	1.47	1.1	3.03	1450	Dir	4G1	DN65	45 mm
2 MYU 200/4/65 FOET5	400	3	1.84	1.5	3.4	1450	Dir	4G1.5+3x1	DN65	65 mm
3 MYU 250/4/65 FOET5	400	3	2.22	1.8	4.3	1450	Dir	4G1.5+3x1	DN65	65 mm
4 MYU 300/4/65 FOET5	400	3	2.7	2.2	5.15	1450	Dir	4G1.5+3x1	DN65	65 mm
5 MYU 400/4/65 GOET5	400	3	3.68	3.0	6.72	1450	Dir	4G1.5+3x1	DN65	65 mm

80 mm discharge bore available

Characteristic curves according to UNI EN ISO 9906

Characteristic curves according to UNI EN ISO 9906

MYU 150-200-250-300/4/80

Performances

	l/s	0	4	8	12	16	20	24
	l/min	0	240	480	720	960	1200	1440
	m ³ /h	0	14.4	28.8	43.2	57.6	72.0	86.4
1	MYU 150/4/80 LOAT5	5.9	5.1	3.9	2.7	1.3		
2	MYU 200/4/80 E0ET5	9.6	8.8	7.0	5.0	3.2	1.7	
3	MYU 250/4/80 E0ET5	10.4	9.7	8.1	6.1	4.2	2.6	1.3
4	MYU 300/4/80 E0ET5	11.3	10.4	9.0	7.4	5.6	3.8	

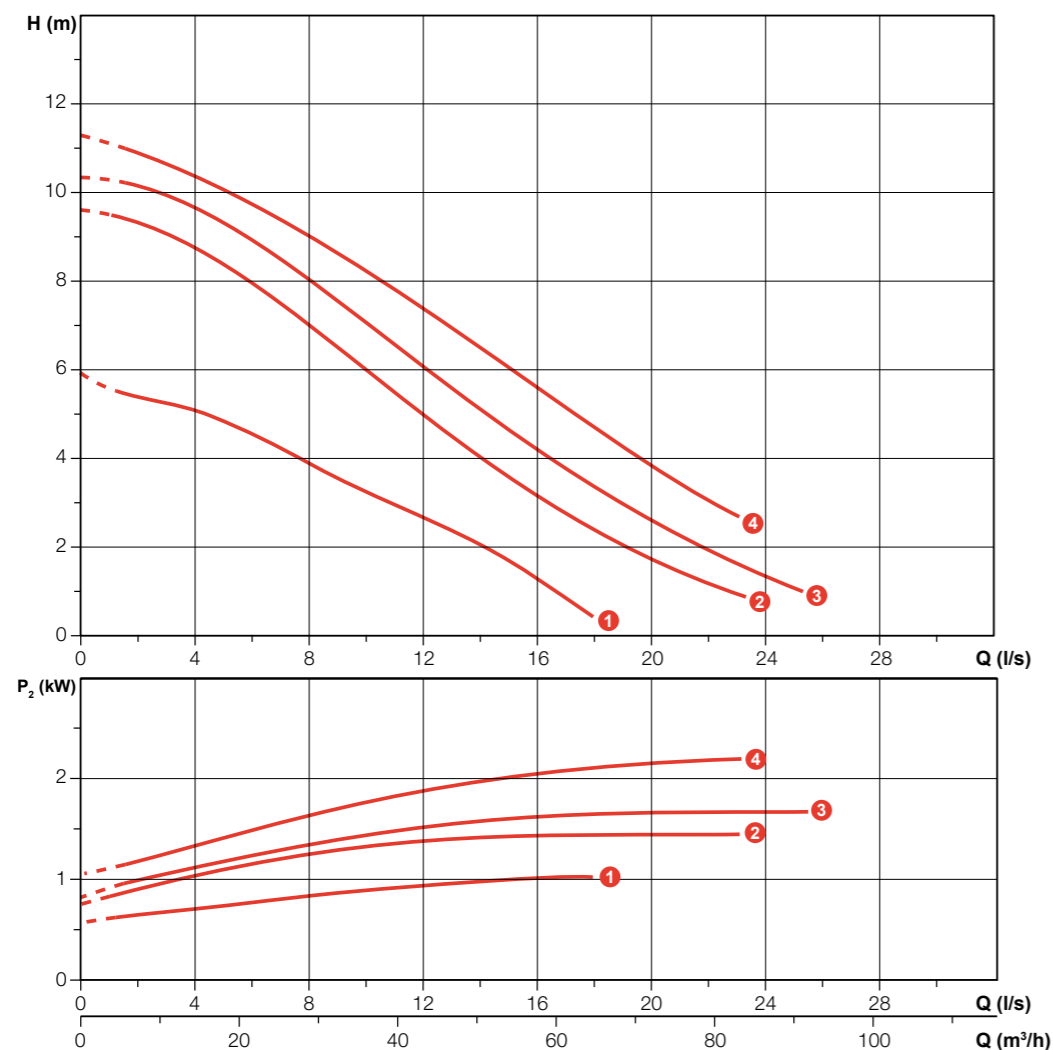

Characteristic curves according to UNI EN ISO 9906

Technical data

	V	Phases	P1 (kW)	P2 (kW)	A	Rpm	Start	Cable	Ø	Free passage	
1	MYU 150/4/80 LOAT5	400	3	1.47	1.1	3.03	1450	Dir	4G1	DN80	80 mm
2	MYU 200/4/80 E0ET5	400	3	1.84	1.5	3.4	1450	Dir	4G1.5+3x1	DN80	80 mm
3	MYU 250/4/80 E0ET5	400	3	2.22	1.8	4.3	1450	Dir	4G1.5+3x1	DN80	80 mm
4	MYU 300/4/80 E0ET5	400	3	2.7	2.2	5.15	1450	Dir	4G1.5+3x1	DN80	80 mm

MYU 400-550-750-1200/4/80

Performances

	l/s	0	4	8	12	16	20	24	28	32	36	40
	l/min	0	240	480	720	960	1200	1440	1680	1920	2160	2400
	m ³ /h	0	14.4	28.8	43.2	57.6	72.0	86.4	100.8	115.2	129.6	144
1	MYU 400/4/80 M0ET5	11.4	10.3	9.2	8.1	6.9	5.5	3.8	1.9			
2	MYU 550/4/80 D0FT5	14.4	13.5	12.7	11.6	10.2	8.6	6.7	4.7			
3	MYU 750/4/80 D0FT5	17.2	16.4	15.6	14.7	13.5	12.0	10.0	7.8	5.5	3.1	0.6
4	MYU 1200/4/80 D0HT5	22.8	22.0	21.4	20.8	20.0	18.9	17.3	15.4	13.0	10.4	7.7

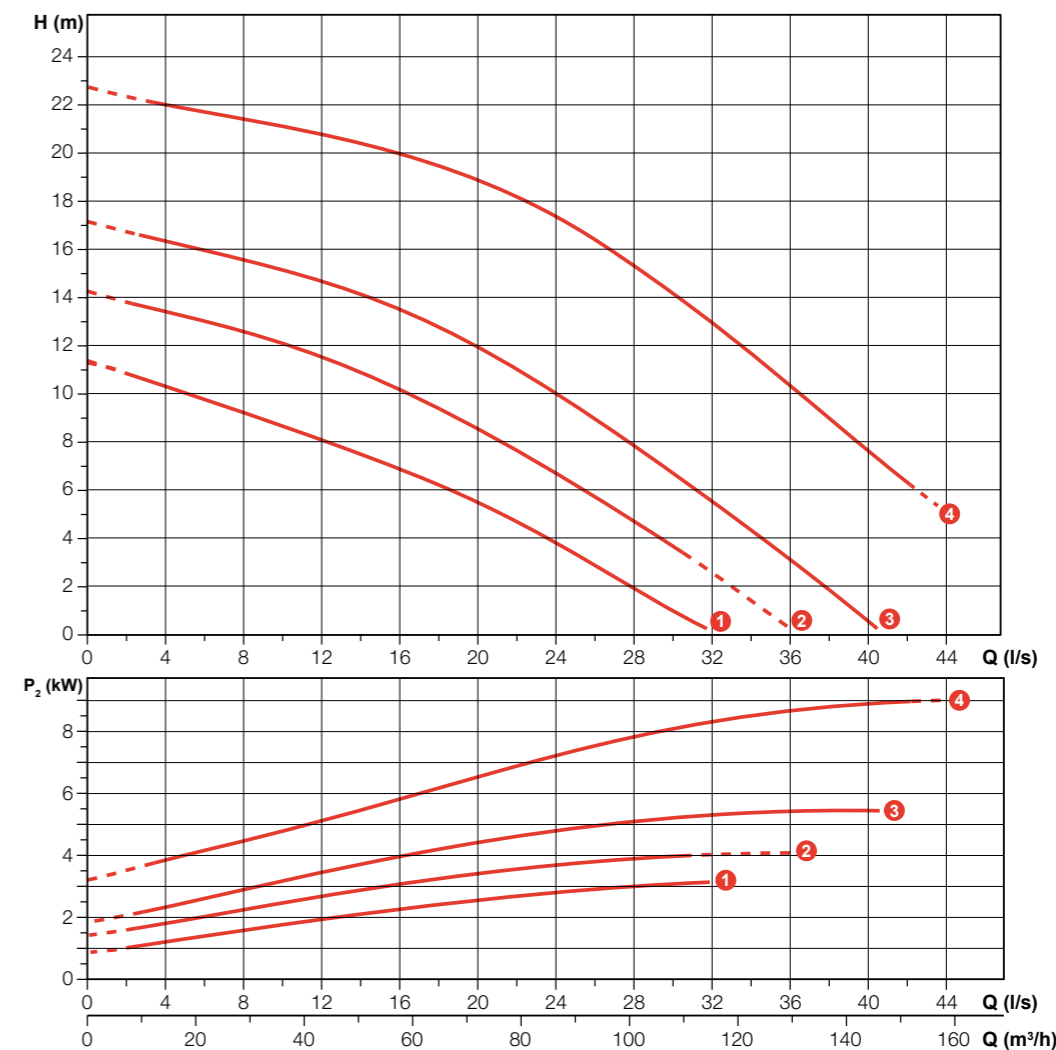

Characteristic curves according to UNI EN ISO 9906

Technical data

	V	Phases	P1 (kW)	P2 (kW)	A	Rpm	Start	Cable	Ø	Free passage	
1	MYU 400/4/80 M0ET5	400	3	3.68	3.0	6.72	1450	Dir	4G1.5+3x1	DN80	80 mm
2	MYU 550/4/80 D0FT5	400	3	4.62	4.0	8.4	1450	Dir	4G1.5+3x1	DN80	60 mm
3	MYU 750/4/80 D0FT5	400	3	6.38	5.5	11.8	1450	Dir	4G1.5+3x1	DN80	60 mm
4	MYU 1200/4/80 D0HT5	400	3	10.2	9.0	17.0	1450	Y Δ	7G1.5+3x1	DN80	60 mm

MYU 200 - 550/4/100

MYU 750 - 2000/4/100

Performances

	l/s	0	4	8	12	16	20	24	28	32	36	40	44
	l/min	0	240	480	720	960	1200	1440	1680	1920	2160	2400	2640
	m³/h	0	14.4	28.8	43.2	57.6	72	86.4	100.8	115.2	129.6	144	158.4
1	MYU 200/4/100 E0ET5	7.9	7.2	5.8	4.2	2.9	2.1						
2	MYU 250/4/100 E0ET5	8.7	8.0	6.4	4.8	3.5	2.6	1.8					
3	MYU 300/4/100 E0ET5	9.7	9.1	7.9	6.4	4.9	3.7	2.9					
4	MYU 400/4/100 D0ET5	10.6	9.8	8.6	7.0	5.6	4.5	3.8	3.1	2.2	1.3		
5	MYU 550/4/100 G0FT5	11.7	11.3	10.6	9.7	8.6	7.6	6.4	5.3	4.2	3.2	2.3	1.4

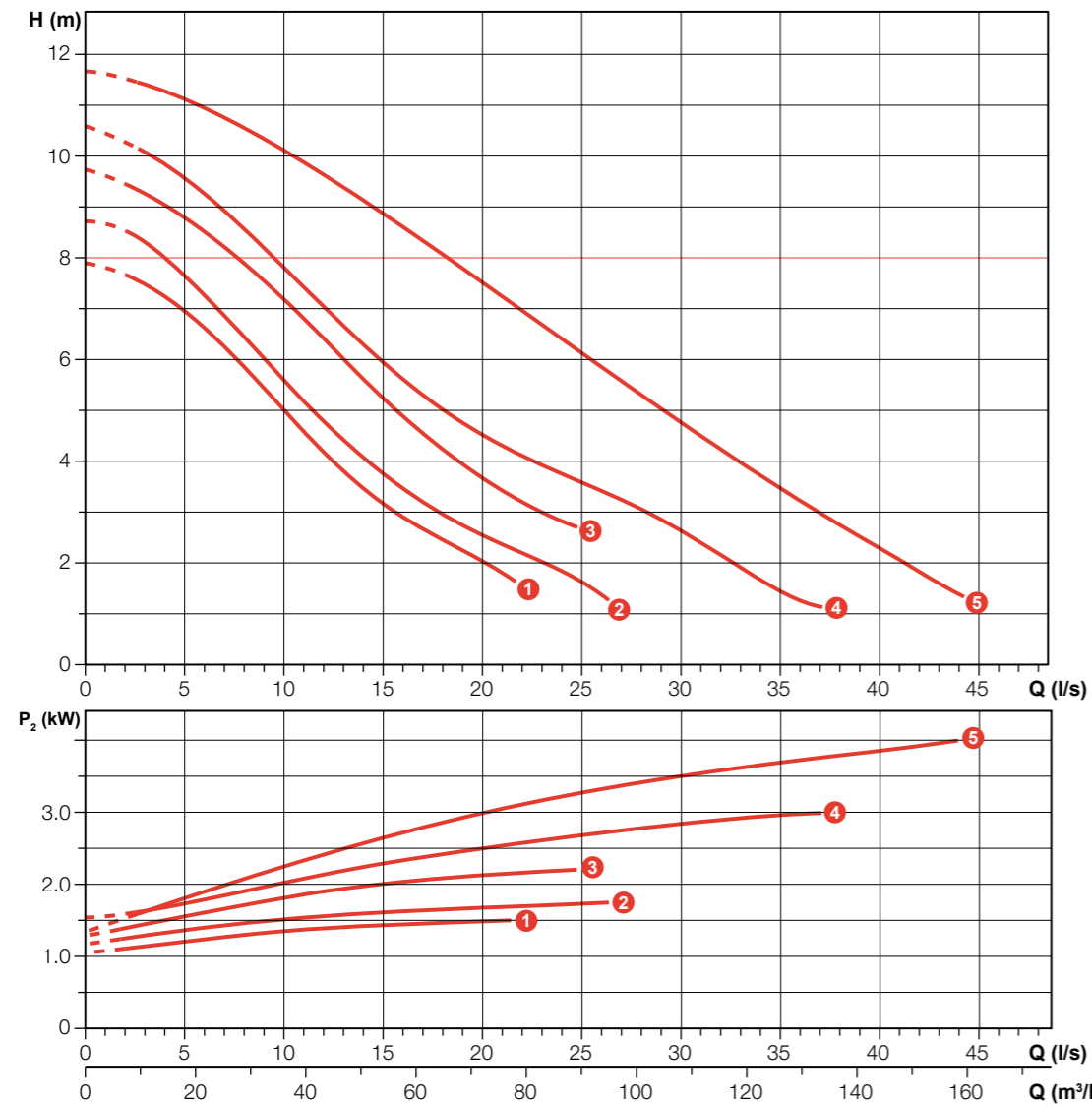

Characteristic curves according to UNI EN ISO 9906

Technical data

	V	Phases	P1 (kW)	P2 (kW)	A	Rpm	Start	Cable	Ø	Free passage	
1	MYU 200/4/100 E0ET5	400	3	1.84	1.5	3.4	1450	Dir	4G1.5+3x1	DN100	100 mm
2	MYU 250/4/100 E0ET5	400	3	2.22	1.8	4.3	1450	Dir	4G1.5+3x1	DN100	100 mm
3	MYU 300/4/100 E0ET5	400	3	2.7	2.2	5.15	1450	Dir	4G1.5+3x1	DN100	100 mm
4	MYU 400/4/100 D0ET5	400	3	3.68	3.0	6.72	1450	Dir	4G1.5+3x1	DN100	100 mm
5	MYU 550/4/100 G0FT5	400	3	4.62	4.0	8.4	1450	Dir	4G1.5+3x1	DN100	80 mm

Performances

	l/s	0	8	16	24	32	40	48	56	64
	l/min	0	480	960	1440	1920	2400	2880	3360	3840
	m³/h	0	28.8	57.6	86.4	115.2	144	172.8	201.6	230.4
1	MYU 750/4/100 G0FT5	13.5	12.1	10.4	8.5	6.6	4.4	2.3		
2	MYU 1200/4/100 B0HT5	20.3	18.8	17.2	15.0	12.3	9.3	6.5	3.8	
3	MYU 1500/4/100 B0HT5	22.7	21.1	19.6	17.6	15.0	12.1	9.2	6.4	3.6
4	MYU 2000/4/100 B0HT5	23.5	22.8	21.4	19.5	17.3	14.8	12.1	9.1	6.0

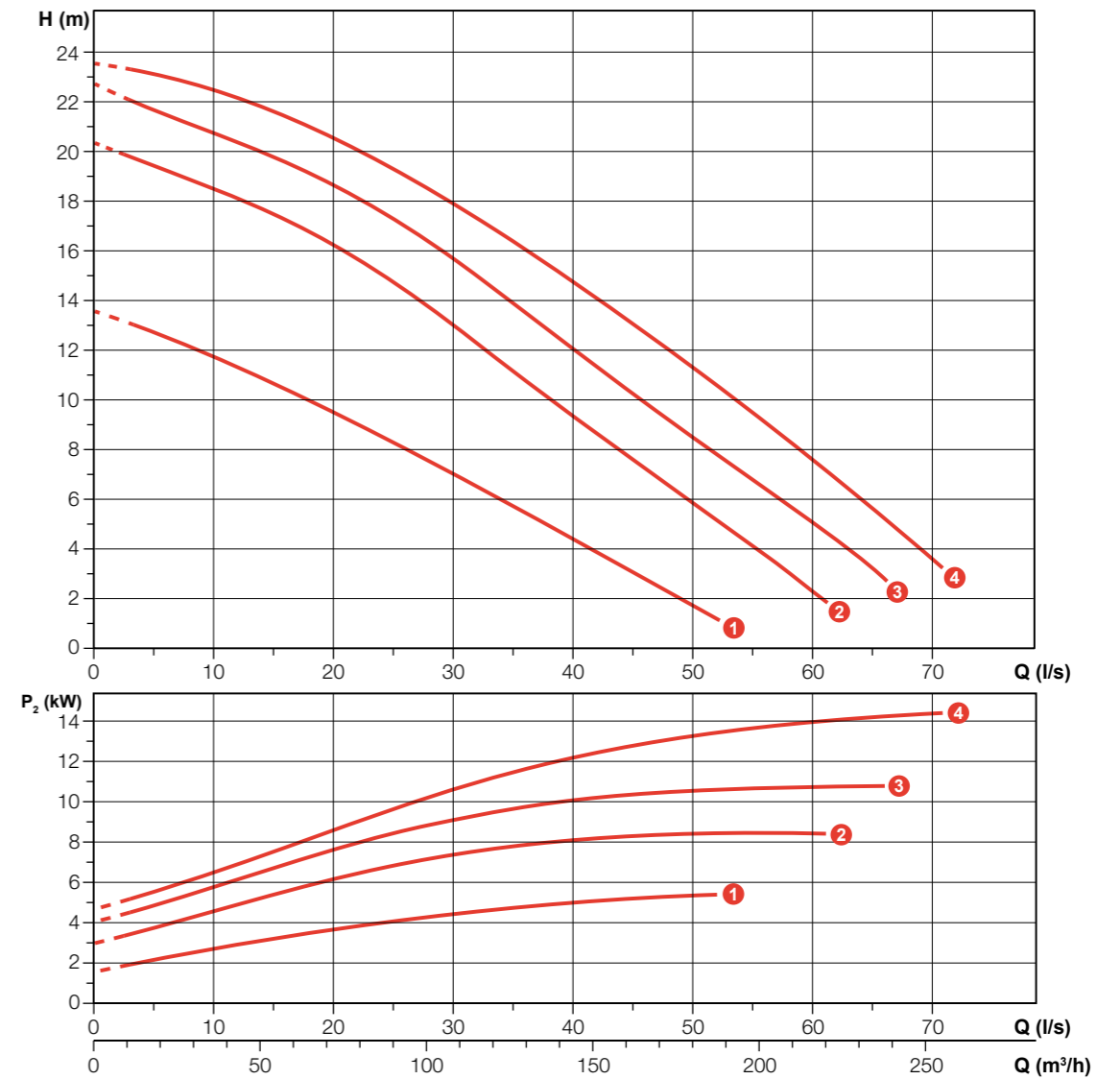

Characteristic curves according to UNI EN ISO 9906

Technical data

	V	Phases	P1 (kW)	P2 (kW)	A	Rpm	Start	Cable	Ø	Free passage	
1	MYU 750/4/100 G0FT5	400	3	6.38	5.5	11.8	1450	Dir	4G1.5+3x1	DN100	80 mm
2	MYU 1200/4/100 B0HT5	400	3	10.2	9.0	17.0	1450	Y Δ	7G1.5+3x1	DN100	100 mm
3	MYU 1500/4/100 B0HT5	400	3	12.6	11.0	20.5	1450	Y Δ	7G1.5+3x1	DN100	100 mm
4	MYU 2000/4/100 B0HT5	400	3	16.7	15.0	30.8	1450	Y Δ	7G1.5+3x1	DN100	100 mm

MYU 1200-1500-2000/4/150

MYU

Performances

	l/s	0	8	16	24	32	40	48	56	64	72	80	88	96	104
	l/min	0	480	960	1440	1920	2400	2880	3360	3840	4320	4800	5280	5760	6240
	m ³ /h	0	28,8	57,6	86,4	115,2	144	172,8	201,6	230,4	259,2	288	316,8	345,6	374,4
① MYU 1200/4/150 A0HT5		11.3	10.6	10.1	9.6	9.0	8.2	7.1	5.7	4.2	2.7	1.5	0.8		
② MYU 1500/4/150 A0HT5		13.3	12.4	11.8	11.4	10.9	10.2	9.2	8.0	6.5	4.8	3.3	1.9		
③ MYU 2000/4/150 A0HT5		16.2	15.2	14.5	13.9	13.3	12.6	11.7	10.6	9.2	7.7	6.2	4.6	3.3	2.3

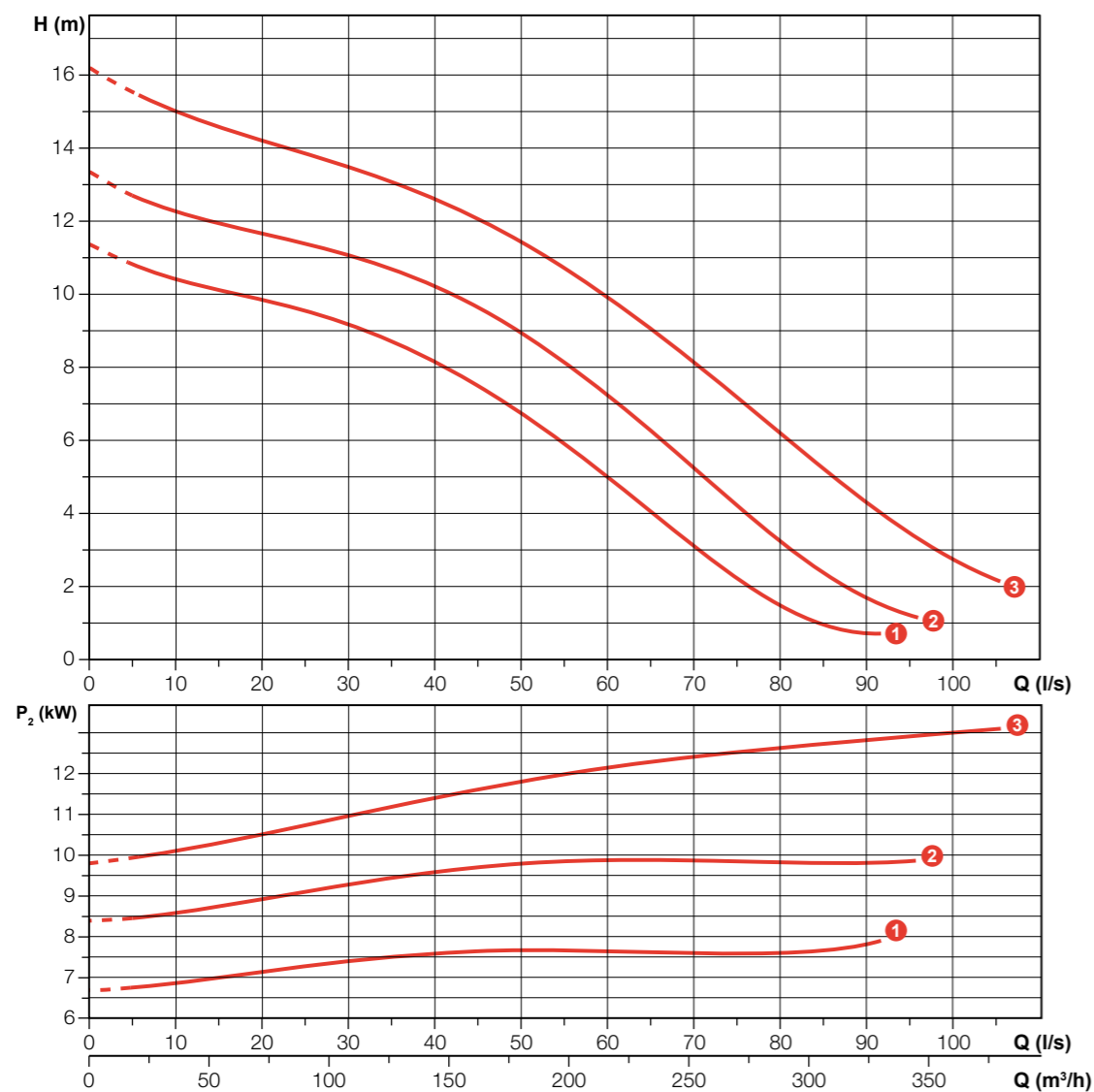

Characteristic curves according to UNI EN ISO 9906

Technical data

	V	Phases	P1 (kW)	P2 (kW)	A	Rpm	Start	Cable	Ø	Free passage
① MYU 1200/4/150 A0HT5	400	3	10.2	9.0	17.0	1450	Y Δ	7G1.5+3x1	DN150	125 mm
② MYU 1500/4/150 A0HT5	400	3	12.6	11.0	20.5	1450	Y Δ	7G1.5+3x1	DN150	125 mm
③ MYU 2000/4/150 A0HT5	400	3	16.7	15.0	30.8	1450	Y Δ	7G2.5+3x1	DN150	125 mm

Overall dimensions and weights

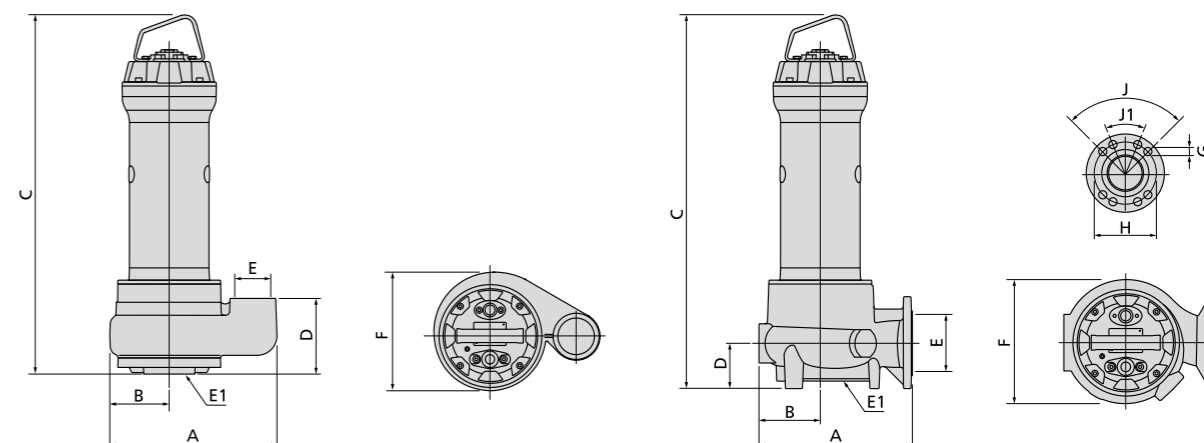

Dimensions in mm

	A	B	C	D	E	E1	F	kg
MYU 250/2/G65V B0AT5	311	109	553	133	2½"	65	219	35.0
MYU 300/2/G65V A0ET5	311	109	576	133	2½"	65	219	59.6

	A	B	C	D	E	E1	F	G	H	J°	J1°	kg
MYU 250/2/65 B0AT5	301	119	553	70	65	65	218	18	145	90	-	37.0
MYU 300/2/65 C0ET5	301	119	576	70	65	65	218	18	145	90	-	61.6
MYU 400/2/65 D0ET5	301	119	626	70	65	65	218	18	145	90	-	64.6
MYU 550/2/65 A0FT5	301	119	733	90	65	65	222	18	145	90	-	70.6
MYU 750/2/65 A0FT5	301	119	733	90	65	65	222	18	145	90	-	73.3
MYU 1000/2/65 A0FT5	301	119	808	90	65	65	222	18	145	90	-	82.3
MYU 250/2/80 F0AT5	312	120	580	80	80	80	236	18	160	90	45	35.0
MYU 300/2/80 G0ET5	312	120	602	80	80	80	236	18	160	90	45	59.6
MYU 400/2/80 H0ET5	312	120	652	80	80	80	236	18	160	90	45	61.6
MYU 550/2/80 N0FT5	313	125	762	92	80	80	251	18	160	90	45	71.0
MYU 750/2/80 A0FT5	313	125	762	92	80	80	251	18	160	90	45	73.7
MYU 1000/2/80 A0FT5	313	125	837	92	80	80	251	18	160	90	45	82.7
MYU 150/4/65 H0AT5	322	129	575	80	65	65	249	18	145	90	-	39.0
MYU 200/4/65 F0ET5	395	158	606	70	65	65	308	18	145	90	-	66
MYU 250/4/65 F0ET5	395	158	656	70	65	65	308	18	145	90	-	68.0
MYU 300/4/65 F0ET5	395	158	656	70	65	65	308	18	145	90	-	70.6
MYU 400/4/65 G0ET5	395	158	656	70	65	65	308	18	145	90	-	75.0
MYU 150/4/80 L0AT5	317	127	580	80	80	80	246	18	160	90	45	39
MYU 200/4/80 E0ET5	389	156	624	80	80	80	306	18	160	90	45	66
MYU 250/4/80 E0ET5	389	156	674	80	80	80	306	18	160	90	45	68.0
MYU 300/4/80 E0ET5	389	156	674	80	80	80	306	18	160	90	45	70.6
MYU 400/4/80 M0ET5	389	156	674	80	80	80	306	18	160	90	45	75.0
MYU 550/4/80 D0FT5	484	194	820	80	80	80	374	18	160	90	45	95.8
MYU 750/4/80 D0FT5	484	194	820	80	80	80	374	18	160	90	45	96.8
MYU 1200/4/80 D0HT5	484	194	968	80	80	80	374	18	160	90	45	186.0
MYU 200/4/100 E0ET5	410	158	645	91	100	100	305	18	180	45	-	69
MYU 250/4/100 E0ET5	410	158	695	91	100	100	305	18	180	45	-	71.0
MYU 300/4/100 E0ET5	410	158	695	91	100	100	305	18	180	45	-	73.6
MYU 400/4/100 D0ET5	410	158	695	91	100	100	305	18	180	45	-	78.0
MYU 550/4/100 G0FT5	408	158	826	91	100	100	305	18	180	45	-	81.8
MYU 750/4/100 G0FT5	408	158	826	91	100	100	305	18	180	45	-	82.8
MYU 1200/4/100 B0HT5	496	190	1032	110	100	100	373	18	180	45	-	193.2
MYU 1500/4/100 B0HT5	496	190	1032	110	100	100	373	18	180	45	-	199.2
MYU 2000/4/100 B0HT5	496	190	1122	110	100	100	373	18	180	45	-	205.2
MYU 1200/4/150 A0HT5	612	222	985	130	150	150	447	24	240	45	-	228.0
MYU 1500/4/150 A0HT5	612	222	985	130	150	150	447	24	240	45	-	234.0
MYU 2000/4/150 A0HT5	612	222	1075	130	150	150	447	24	240	45	-	240.0

MYU

Packaging dimension



	X	Y	Z
MYU 250/2/G65V B0AT5	445	725	425
MYU 300/2/G65V C0ET5	445	725	425
MYU 250/2/65 B0AT5	445	725	425
MYU 300/2/65 C0ET5	445	725	425
MYU 400/2/65 D0ET5	445	725	425
MYU 550/2/65 A0FT5	535	915	560
MYU 750/2/65 A0FT5	535	915	560
MYU 1000/2/65 A0FT5	535	915	560
MYU 250/2/80 F0AT5	445	725	425
MYU 300/2/80 G0ET5	445	725	425
MYU 400/2/80 H0ET5	445	725	425
MYU 550/2/80 N0FT5	535	915	560
MYU 750/2/80 A0FT5	535	915	560
MYU 1000/2/80 A0FT5	535	915	560
MYU 150/4/65 H0AT5	445	725	425
MYU 200/4/65 F0ET5	445	725	425
MYU 250/4/65 F0ET5	445	725	425
MYU 300/4/65 F0ET5	445	725	425
MYU 400/4/65 G0ET5	445	725	425
MYU 150/4/80 L0AT5	445	725	425
MYU 200/4/80 E0ET5	445	725	425
MYU 250/4/80 E0ET5	445	725	425
MYU 300/4/80 E0ET5	445	725	425
MYU 400/4/80 M0ET5	445	725	425
MYU 550/4/80 D0FT5	535	915	560
MYU 750/4/80 D0FT5	535	915	560
MYU 1200/4/80 D0HT5	535	1000	560
MYU 200/4/100 E0ET5	445	725	425
MYU 250/4/100 E0ET5	445	725	425
MYU 300/4/100 E0ET5	445	725	425
MYU 400/4/100 D0ET5	445	725	425
MYU 550/4/100 G0FT5	535	915	560
MYU 750/4/100 G0FT5	535	915	560
MYU 1200/4/100 B0HT5	725	1270	675
MYU 1500/4/100 B0HT5	725	1270	675
MYU 2000/4/100 B0HT5	725	1270	675
MYU 1200/4/150 A0HT5	725	1270	675
MYU 1500/4/150 A0HT5	725	1270	675
MYU 2000/4/150 A0HT5	725	1270	675

Dimensions in mm

MYG

Grinder impeller

Operating ranges

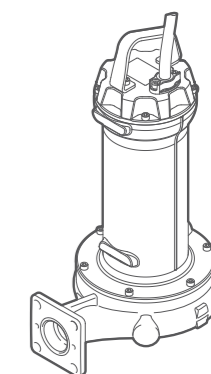
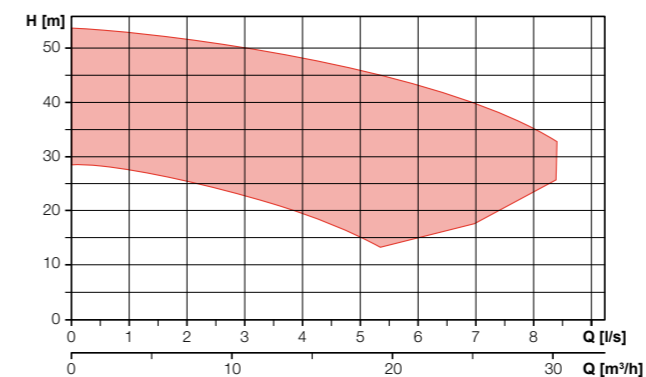

Range characteristics

Motor power	1.8 - 7.5 kW
Poles	2
Insulation class	H
Degree of protection	IP68
Discharge	GAS 1½" - 2" DN32 horizontal
Free passage	-
Max flow rate	8.4 l/s
Max head	53.7 m

Motor

Ecological dry motor with thermal protections

Cable

S1RN8-F electric cable. Standard version 10 m cable length

Mechanical seals

Two silicon carbide (SiC) mechanical seals in oil sump

Applications

Designed for professional and industrial use, it is suitable for the treatment of liquids containing suspended solids or fibres.

Versions

Electrical variants	NAE, TS
Cooling system	N
Mechanical seals	2SiC

Operating specifications

Max operating temperature	40 °C
PH of treated fluid	6 - 14
Viscosity of treated fluid	1 mm²/s
Maximum immersion depth	20 m
Density of treated fluid	1 Kg/dm³
Acoustic pressure max	<70dB
Max starts per hour	30

Construction materials

Case	Cast iron EN-GJL 250
Hydraulic parts	Cast iron EN-GJL 250
Impeller	Cast iron EN-GJL 250
Nuts and bolts	Stainless steel - Class A2-70
Standard gasket	Rubber - NBR
Shaft	Stainless steel - AISI 431
Cutter	Chromium steel
Paint type	Ecological bicomponent epoxy (~ 200 µm)

Installations

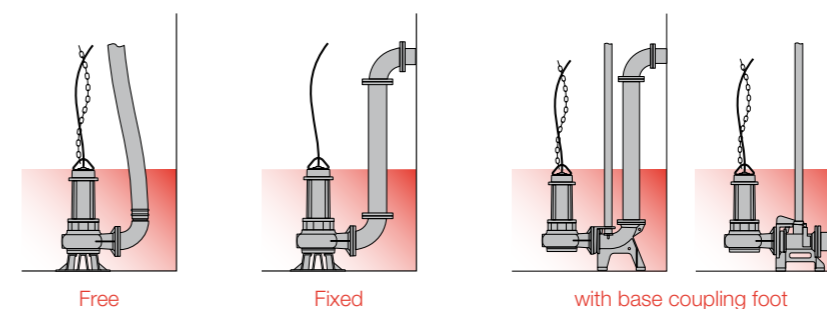

MYG 250/2/G40H

MYG 300 - 1000/2/G50H

Performances

	l/s	0	0.5	1.0	1.5	2.0	2.5	3.0	3.5	4.0	4.5	5.0
	l/min	0	30	60	90	120	150	180	210	240	270	300
	m ³ /h	0	1.8	3.6	5.4	7.2	9.0	10.8	12.6	14.4	16.2	18.0
1 MYG 250/2/G40H A0AT5		28.5	28.2	27.5	26.5	25.4	24.1	22.7	21.2	19.4	17.3	14.9

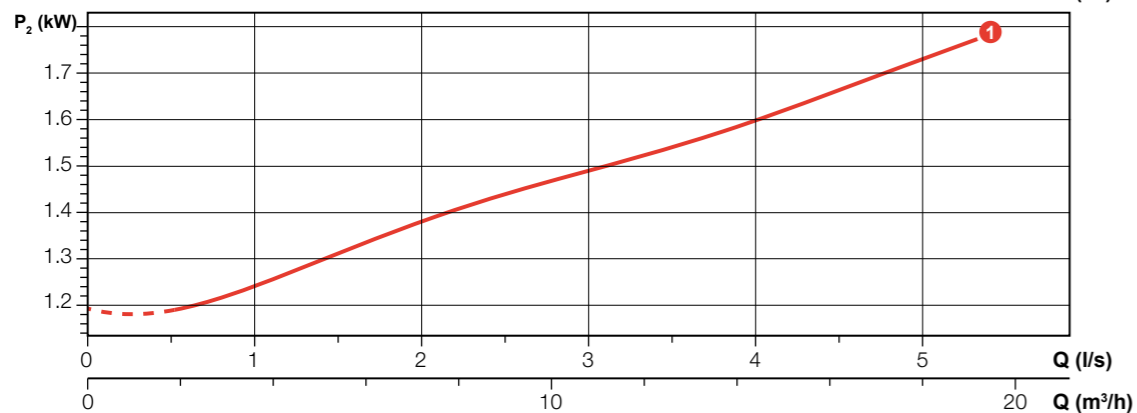
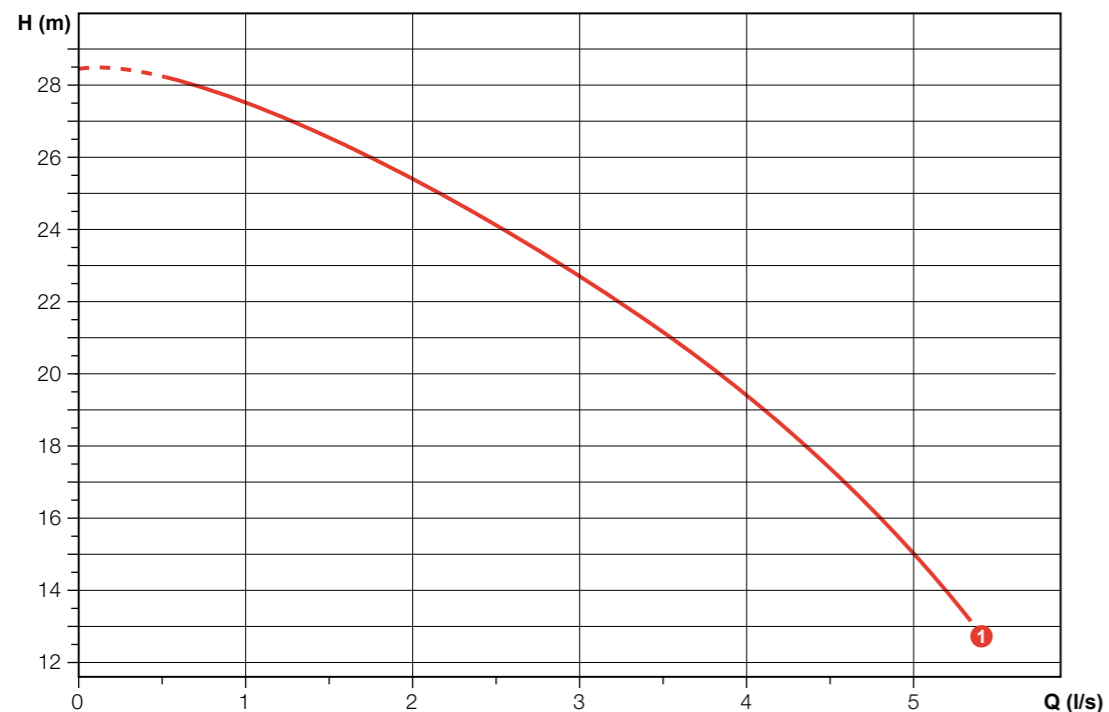

Characteristic curves according to UNI EN ISO 9906

Technical data

	V	Phases	P1 (kW)	P2 (kW)	A	Rpm	Start	Cable	Ø	Free passage
1 MYG 250/2/G40H A0AT5	400	3	2.19	1.8	3.7	2900	Dir	4G1	DN32-G1½"	-

Performances

	l/s	0	1	2	3	4	5	6	7	8
	l/min	0	60	120	180	240	300	360	420	480
	m ³ /h	0	3.6	7.2	10.8	14.4	18	21.6	25.2	28.8
1 MYG 300/2/G50H C0ET5		30.3	29.3	27.9	26.1	24.0	21.6			
2 MYG 400/2/G50H D0ET5		35.8	34.8	33.0	31.1	28.5	25.3	21.8	17.7	
3 MYG 550/2/G50H D0T5		45.1	44.4	42.8	40.6	38.1	35.3			
4 MYG 750/2/G50H A0FT5		46.6	45.9	44.6	42.8	40.8	38.5	35.8	32.4	27.9
5 MYG 1000/2/G50H A0FT5		53.7	52.9	51.6	50.0	48.2	46.0	43.3	39.8	35.2

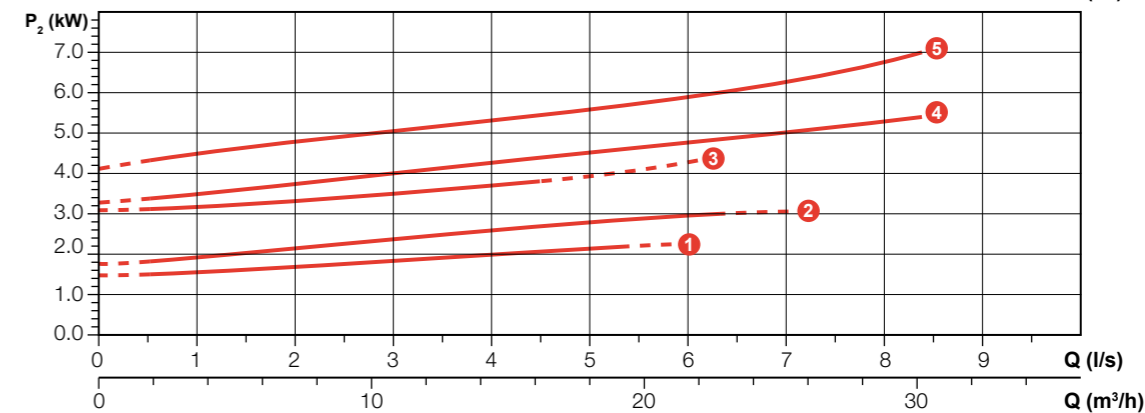
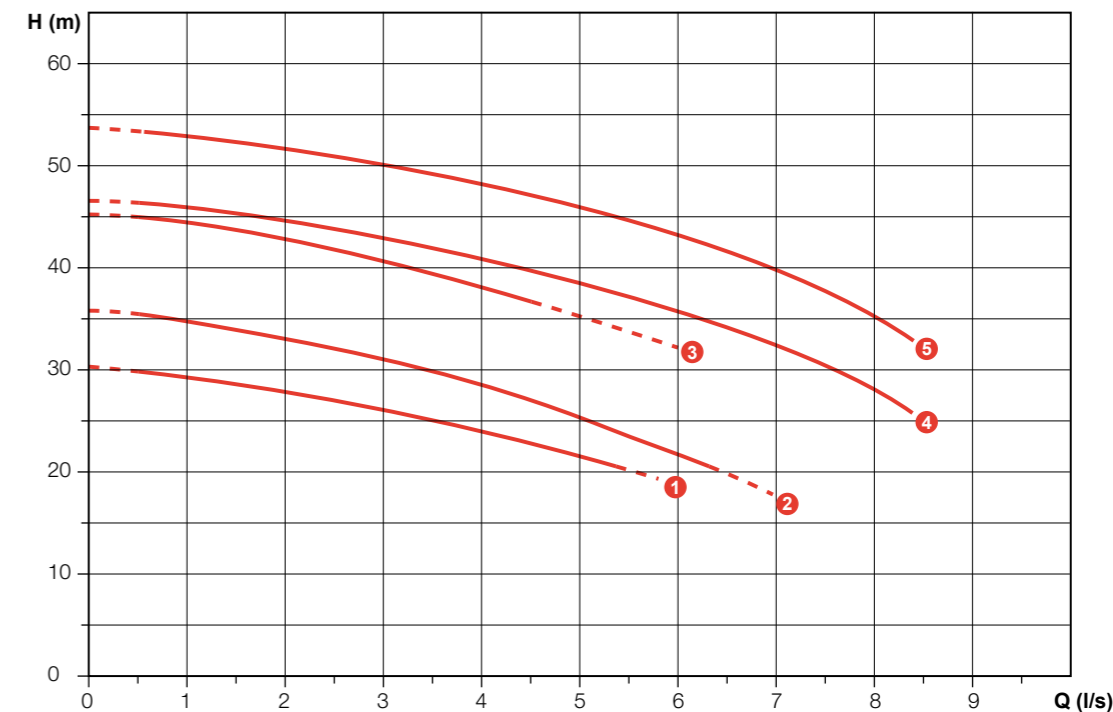

Characteristic curves according to UNI EN ISO 9906

Technical data

	V	Phases	P1 (kW)	P2 (kW)	A	Rpm	Start	Cable	Ø	Free passage
1 MYG 300/2/G50H C0ET5	400	3	2.76	2.2	4.62	2900	Dir	4G1.5+3x1	DN32-G2"	-
2 MYG 400/2/G50H D0ET5	400	3	3.68	3.0	6.36	2900	Dir	4G1.5+3x1	DN32-G2"	-
3 MYG 550/2/G50H D0T5	400	3	4.66	4.0	7.73	2900	Dir	4G1.5+3x1	DN32-G2"	-
4 MYG 750/2/G50H A0FT5	400	3	6.32	5.5	10.8	2900	Dir	4G1.5+3x1	DN32-G2"	-
5 MYG 1000/2/G50H A0FT5	400	3	8.51	7.5	13.7	2900	Dir	4G1.5+3x1	DN32-G2"	-

MYG

MYS

Overall dimensions and weights

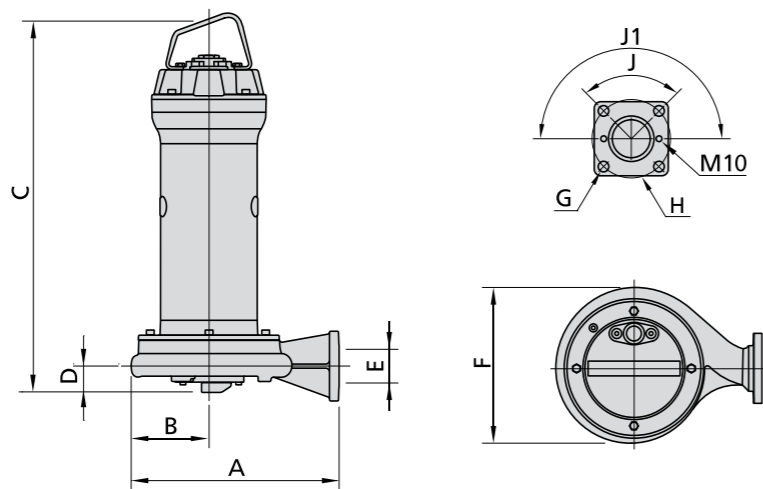

	A	B	C	D	E	F	G	H	J°	J1°	kg
MYG 250/2/G40H A0AT5	267	103	491	45	GAS 1½"- DN32	215	14	90	-	90	32.0
MYG 300/2/G50H C0ET5	305	110	527	56	GAS 2"- DN32	225	18	125	90	180	58.6
MYG 400/2/G50H D0ET5	352	132	594	59	GAS 2"- DN32	263	18	125	90	180	59.6
MYG 550/2/G50H D0T5	352	128	652	59	GAS 2"- DN32	263	18	125	90	180	57.0
MYG 750/2/G50H A0FT5	352	128	652	59	GAS 2"- DN32	263	18	125	90	180	59.7
MYG 1000/2/G50H A0FT5	352	128	727	59	GAS 2"- DN32	263	18	125	90	180	68.7

Dimensions in mm

Packaging dimension



	X	Y	Z
MYG 250/2/G40H A0AT5	310	580	310
MYG 300/2/G50H C0ET5	445	725	425
MYG 400/2/G50H D0ET5	445	725	425
MYG 550/2/G50H D0T5	445	725	425
MYG 750/2/G50H A0FT5	445	725	425
MYG 1000/2/G50H A0FT5	535	915	560

Dimensions in mm

High head impeller

Operating ranges

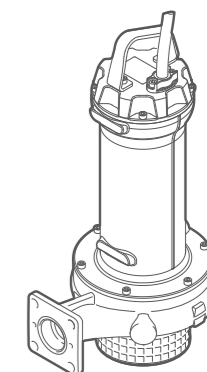
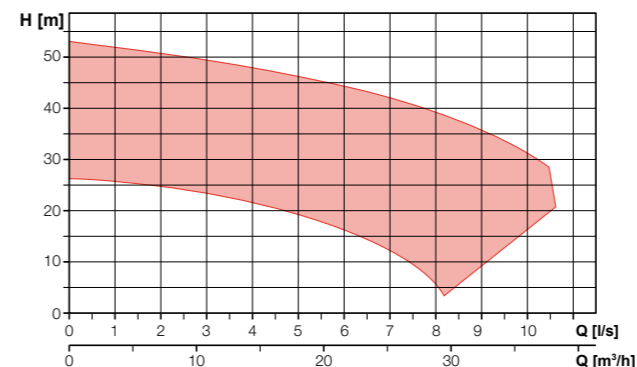

Range characteristics

Motor power	1.8 - 7.5 kW
Poles	2
Insulation class	H
Degree of protection	IP68
Discharge	GAS 1½ - 2" DN32 horizontal
Free passage	max 10 mm
Max flow rate	10.5 l/s
Max head	53.0 m

Motor

Ecological dry motor with thermal protections.

Cable

S1RN8-F electric cable. Standard version 10 m cable length.

Mechanical seals

Two silicon carbide (SiC) mechanical seals in oil sump.

Applications

The considerable manometric head guarantees excellent results for the creation of water features and decorative fountains; suitable for use in agriculture, irrigation and the fish processing sector.

Installations

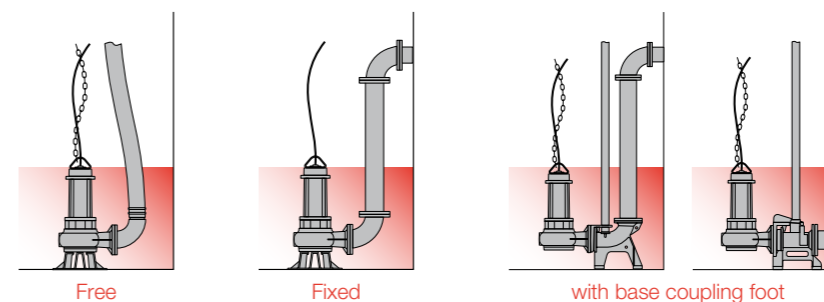

Versions

Electrical variants	NAE, TS
Cooling system	N
Mechanical seals	2SiC

Operating specifications

Max operating temperature	40 °C
PH of treated fluid	6 - 14
Viscosity of treated fluid	1 mm²/s
Maximum immersion depth	20 m
Density of treated fluid	1 Kg/dm³
Acoustic pressure max	<70dB
Max starts per hour	30

Construction materials

Case	Cast iron EN-GJL 250
Hydraulic parts	Cast iron EN-GJL 250
Impeller	Cast iron EN-GJL 250
Nuts and bolts	Stainless steel - Class A2-70
Standard gasket	Rubber - NBR
Shaft	Stainless steel - AISI 431
Strainer	Stainless steel - AISI 304
Paint type	Ecological bicomponent epoxy (~ 200 µm)

MYS 250/2/G40H

MYS 300 - 1000/2/G50H

Performances

	l/s	0	1	2	3	4	5	6	7
	l/min	0	60	120	180	240	300	360	420
	m ³ /h	0	3.6	7.2	10.8	14.4	18	21.6	25.2
1	MYS 250/2/G40H A0AT5	26.0	25.7	24.6	23.3	21.6	19.2	16.2	12.3

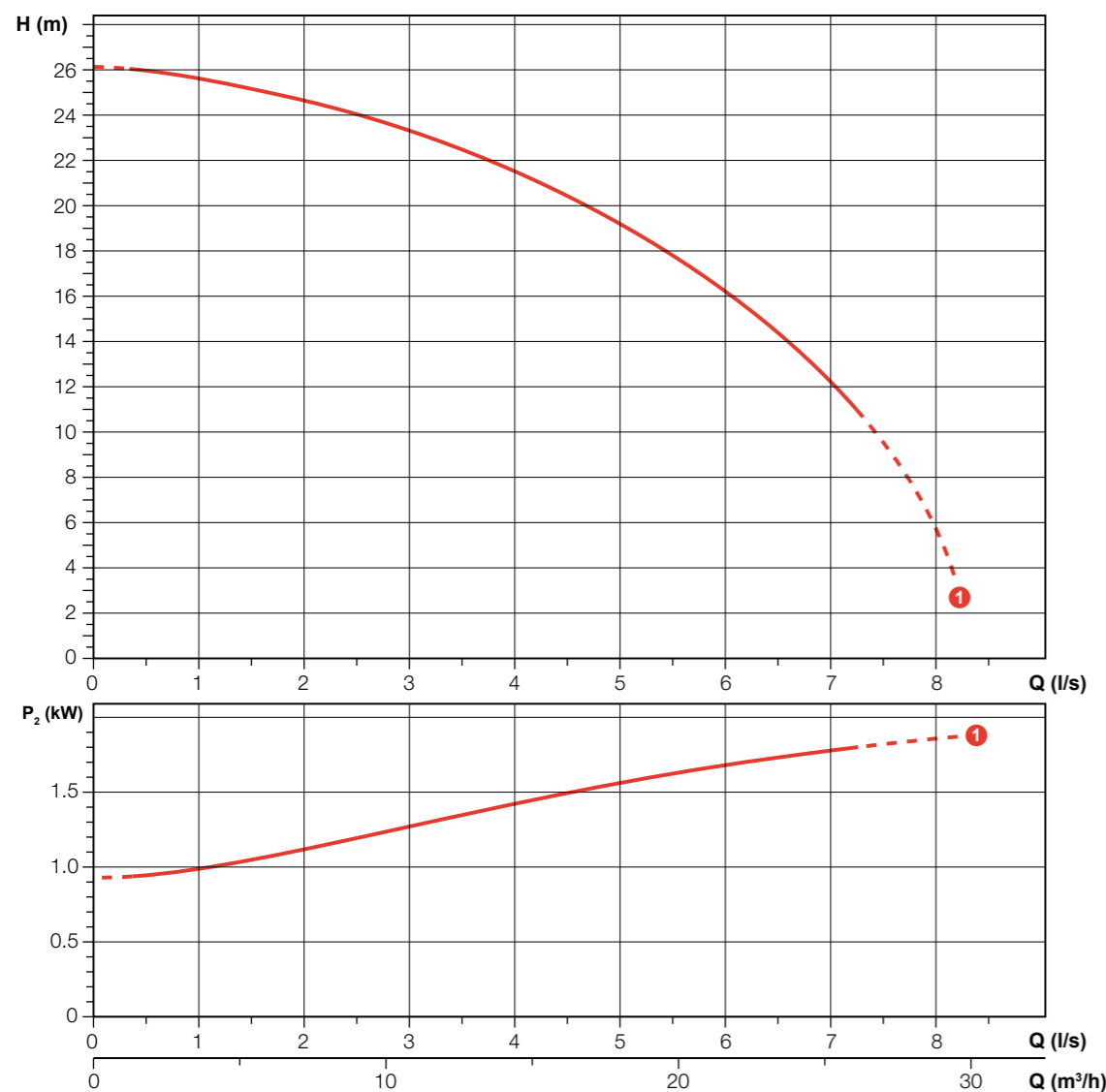

Characteristic curves according to UNI EN ISO 9906

Technical data

	V	Phases	P1 (kW)	P2 (kW)	A	Rpm	Start	Cable	Ø	Free passage
1	400	3	2.19	1.8	3.7	2900	Dir	4G1	DN32-G 1½"	10 mm

Performances

	l/s	0	1	2	3	4	5	6	7	8	9	10
	l/min	0	60	120	180	240	300	360	420	480	540	600
	m ³ /h	0	3.6	7.2	10.8	14.4	18	21.6	25.2	28.8	32.4	36
1	MYS 300/2/G50H C0ET5	29.2	28.2	27.0	25.6	24.1	22.5	20.4	17.6			
2	MYS 400/2/G50H D0ET5	32.2	31.4	29.9	28.5	27.2	25.9	24.4				
3	MYS 550/2/G50H D0FT5	38.6	37.6	36.1	34.5	32.9	31.3	29.6	27.7	25.4		
4	MYS 750/2/G50H A0FT5	45.8	44.5	43.5	42.2	40.7	38.9	36.8	34.5	31.8	28.6	24.2
5	MYS 1000/2/G50H A0FT5	53.0	51.8	50.7	49.4	48.0	46.3	44.3	42.0	39.2	35.8	31.2

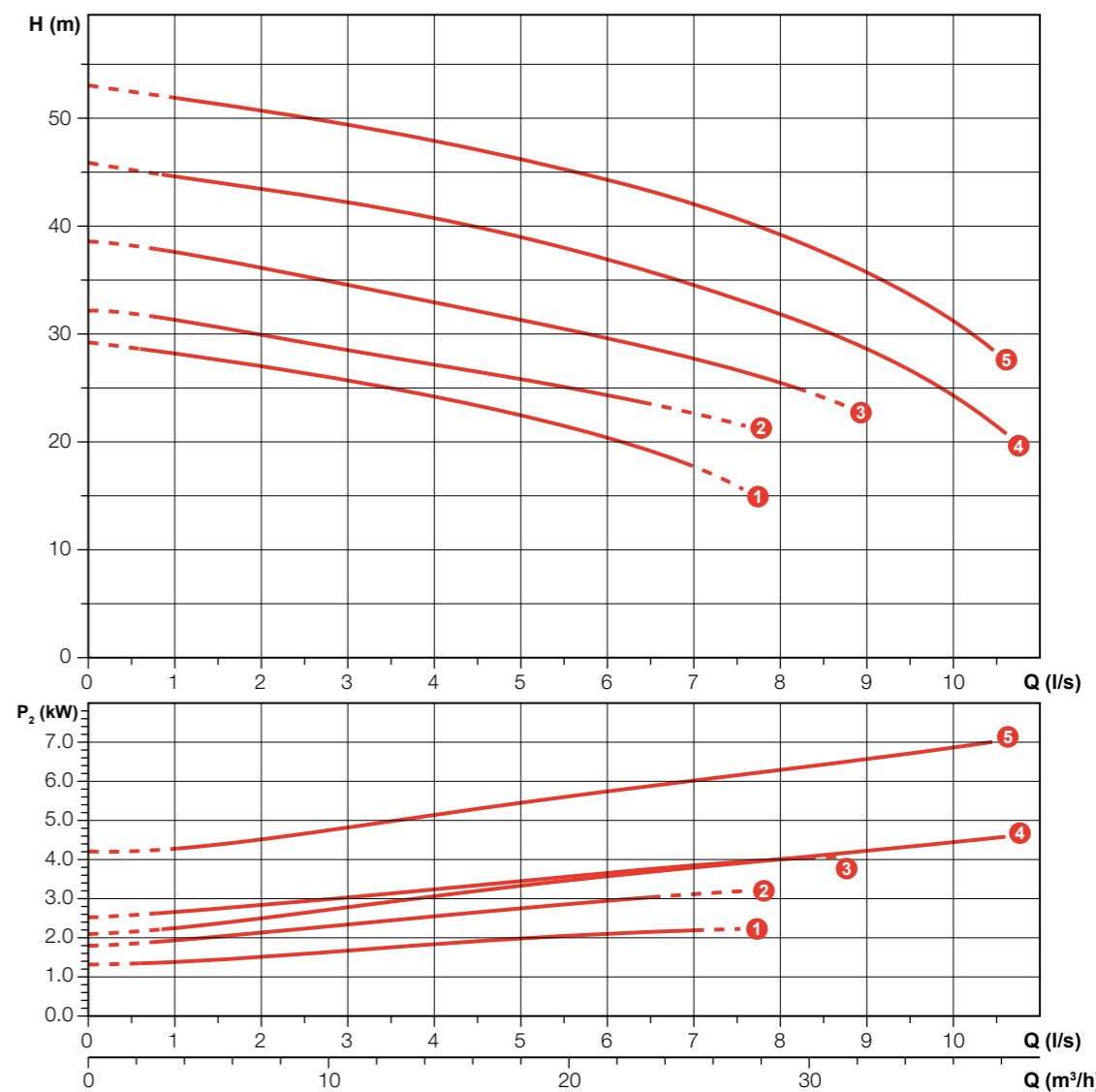

Characteristic curves according to UNI EN ISO 9906

Technical data

	V	Phases	P1 (kW)	P2 (kW)	A	Rpm	Start	Cable	Ø	Free passage
1	400	3	2.76	2.2	4.62	2900	Dir	4G1.5+3x1	DN32-G2"	8 mm
2	400	3	3.68	3.0	6.36	2900	Dir	4G1.5+3x1	DN32-G2"	8 mm
3	400	3	4.66	4.0	7.73	2900	Dir	4G1.5+3x1	DN32-G2"	8 mm
4	400	3	6.32	5.5	10.8	2900	Dir	4G1.5+3x1	DN32-G2"	10 mm
5	400	3	8.51	7.5	13.7	2900	Dir	4G1.5+3x1	DN32-G2"	10 mm



Product images and specifications may differ from actual products due to improvements.
The OO series and model OO are indicated with our series/model codes in this booklet.